



---

# CRYSTAL

## 9000Btu

---

### Portable Air Conditioner

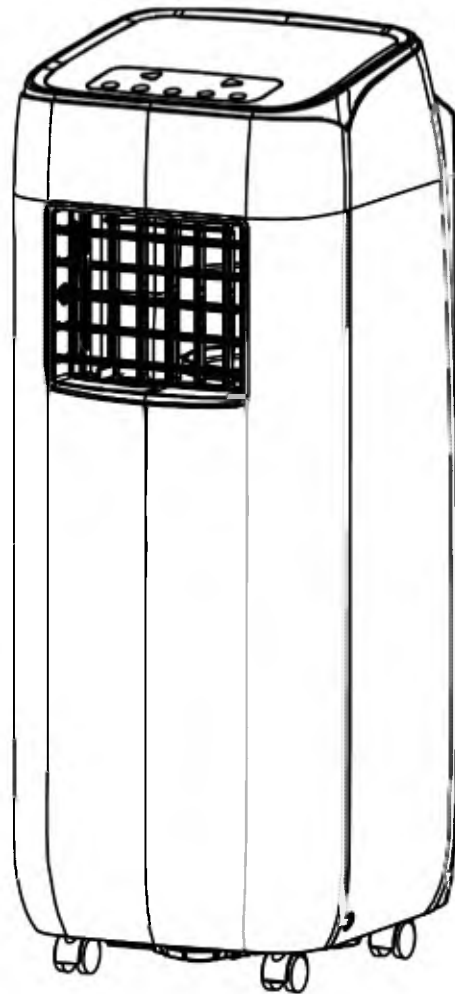

## Congratulations!

You have purchased the very latest in room air conditioning technology. Your new EcoAir high efficiency room appliance will give you many years of dependable service. Many features have been built into your EcoAir portable appliance to assure quiet operation, the best circulation of cool and dry air, functional controls and the most economical operation.

Index.....	1
BS Plug Wiring .....	2
Important Safety Instructions.....	3-7
Introduction .....	8
Installation.....	9 - 15
Quick Set Up.....	16 - 19
Cleaning & Maintenance.....	20 - 21
Troubleshooting .....	21 - 23
Specifications .....	24
Guarantee Card .....	25

### When using this appliance in European countries, the following information must be observed:

Do not dispose of this product as unsorted waste.

It is prohibited to dispose of this appliance as domestic household waste. For disposal:

- Contact your local council
- The manufacturer will take back the old appliance for disposal when you replace it with a new product.
- Old products contain valuable resources, which should be recycled as scrap metal.



Wild disposal of waste in forests and landscapes endangers your health when hazardous substances leak into the ground-water and find their way into the food chain.

# BS PLUG WIRING

## BS PLUG WIRING

**Wiring Instructions:** Should it be necessary to change the plug, please note the wires in the mains lead are coloured in accordance with the following codes:

**BLUE - NEUTRAL**  
**BROWN – LIVE**  
**GREEN AND YELLOW - EARTH**

In the event that the colours of the wires in the mains lead of this appliance do not correspond with the coloured markings identifying the terminals in your plug, proceed as follows:

1. The **BLUE** wire is **NEUTRAL** and must be connected to the terminal which is marked with the letter **N** or coloured **BLACK**.
2. The **BROWN** wire is **LIVE** and must be connected to the terminal which is marked with the letter **L** or coloured **RED**.
3. The **GREEN/YELLOW** is **EARTH** and must be connected to the terminal which is marked with the letter **E** or  $\oplus$  or coloured **GREEN** or **GREEN/YELLOW**.
4. Always ensure that the cord grip is positioned and fastened correctly.

If a **13A (BS 1363)** fused plug is used it must be fitted with a **13A** -fuse. If in doubt consult a qualified electrician.

### Wiring for a 13 Amp Plug (BS1363)

Please note. The Earth Terminal is marked with the letter **E** or  $\oplus$  Earth Symbol.

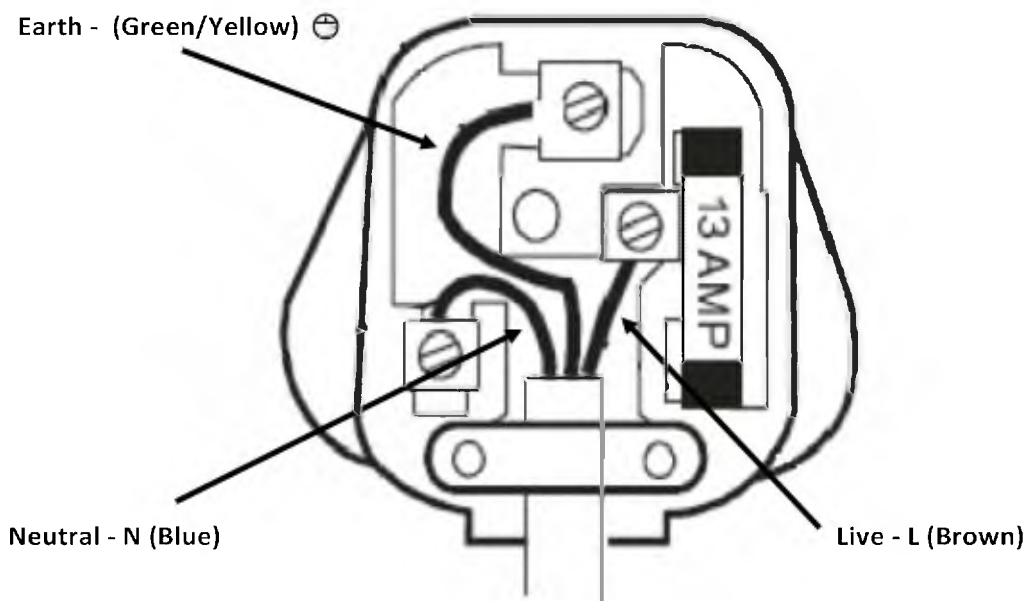

# IMPORTANT SAFETY INSTRUCTIONS

PLEASE READ ALL INSTRUCTIONS CAREFULLY BEFORE OPERATING.

## WARNING!

This air conditioner is for use in domestic households and similar working as well as residential environments and is not for outdoor use. It must be used only as a domestic appliance. EcoAir cannot be held liable for damage resulting from incorrect or improper use or operation



## When using electrical appliances, basic safety precautions should always be followed:

1. Do not operate the appliance if there is a damaged cord plug or after it malfunctions if it has been dropped or damaged in any way. Arrange for the appliance to be examined or repaired by an authorised technician.
2. Always keep the appliance in an upright position to avoid any damage. Place the appliance on an even level surface during operation.
3. Ensure the household voltage matches the rated specification for the appliance before use.
4. Operate this appliance in an ambient temperature between 16°C and 35°C.
5. Ensure that the air inlets and outlets are not blocked or covered. Do not insert fingers or any objects into the air inlet or outlet openings.
6. Do not place the unit too close to curtains or any other objects, keep minimum distance of 50cm.
7. Never place anything on top of the appliance and do not cover while in use.
8. To protect against electric shocks, do not immerse or spray the appliance or any of its parts in water.
9. Never unplug the power cord without switching OFF the appliance first.
10. Always unplug the appliance when not in use or when moving location. To disconnect the appliance from the power supply, grip the plug and pull from the power socket. Never pull by the cord.
11. Always empty the internal water tank before storing the appliance away.
12. Close supervision is necessary when the appliance is used in the presence of children and pets.
13. Do not run power cord under carpeting, or cover with rugs or runners. Arrange the cord away from areas where it may become a trip hazard.
14. Never operate or store the appliance in direct sunlight.
15. Repairs must be carried out by an authorised technician, failure to do so may cause damage to the appliance or injury to persons or property and will void the warranty. Always insist on original spare parts.
16. Do not connect via an extension lead or Multi-socket plug. Extension leads and Multi-socket plugs do not guarantee the required safety of the appliance (e.g. danger of overheating).
17. Do not use the appliance without the air filter. Clean or replace the air filter regularly.
18. Do not leave the appliance unattended in continuous drainage over a long period of time.
19. At the end of its working life dispose of the appliance responsibly, in accordance with local regulations.
20. Before cleaning or maintaining the appliance, please turn off the power and pull out the power plug.
21. Do not insert or pull out the power plug with wet hands.
22. Do not insert any objects into the appliance.
23. Do not splash or pour water onto appliance. Otherwise, it may cause short circuit or damage to it.
24. Do not operate heating equipment around the appliance.
25. Keep a safe distance from fire source, inflammable and explosive objects.
26. Keep children from playing or climbing with or on the appliance.
27. Do not put clothes above the appliance to dry.
28. Do not use in server room.
29. Never open the unit casing yourself and attempt to repair. This will void the warranty and is a potential health and safety risk.

This appliance is not intended for use by persons (including children) with reduced physical, sensory or mental capabilities, unless they have been given supervision or instruction concerning use of the appliance by a person responsible for their safety. Children should be supervised to ensure that they do not play with the appliance.

**READ & SAVE THESE IMPORTANT SAFETY INSTRUCTIONS FOR FUTURE REFERENCE**

# The Refrigerant R32 Gas

	Read the precautions in this manual carefully		This appliance is filled with R32.
---	---	---	------------------------------------

- The warnings and cautions described below both contain important information regarding safety. Be sure to observe all warnings without fail.  
**WARNING ....Failure to follow these instructions properly may result in personal injury or loss of life.**
- As of the production date of this air conditioner this manual is the most up to date version. This manual may be subject to change post production without notice. Please visit [www.ecoair.org](http://www.ecoair.org) for the most up to date version of this manual.

<b>WARNING</b>
<ul style="list-style-type: none"> <li>Install the air conditioner on a foundation strong enough to withstand the weight of the unit. A foundation of insufficient strength may result in the equipment falling and causing injury.</li> </ul>
<ul style="list-style-type: none"> <li>The used refrigerant is the fluoride R32. This is a non polluting refrigerant that does not harm the ozoneosphere. It has a low GWP (Global Warming Potential) compared with R410A.</li> </ul>
<ul style="list-style-type: none"> <li>R32 has got very good thermodynamic features which lead to a really high energy efficiency. The units therefore requires less gas to operate.</li> </ul>
<ul style="list-style-type: none"> <li>According to International Standards ISO 817:2014 R32 is rated as A2L—Lower toxicity (A), and lower risk of flammability (2L)</li> </ul>
<ul style="list-style-type: none"> <li>R32 Gas is a lower flammability refrigerant with a maximum burning velocity of &lt;10cm/s according to International Standards ISO 5149</li> </ul>
<ul style="list-style-type: none"> <li>R32 Gas will not combust unless three conditions, in specific quantities or with sufficient energy are met: 1) Refrigerant concentration (14 to 31volume % - 0,3 to 0,6kg/m3 2) Constant oxygen 3) An ignition source (30 to 100mJ [static electricity 1,25mJ)</li> </ul>
<ul style="list-style-type: none"> <li>If the refrigerant R32 gas leaks, ventilate the area immediately. Toxic gas may be produced if the refrigerant comes into contact with fire or an ignition source.</li> </ul>
<ul style="list-style-type: none"> <li>All the work men who are engaging in the refrigeration system should bear the valid certification awarded by the authoritative organisation and the qualification for dealing with the refrigeration system recognised by this industry. If it needs any other technician to maintain and repair the air conditioner, they should be supervised by the person who bears the qualification for using the flammable refrigerant.</li> </ul>
<ul style="list-style-type: none"> <li>While not in use the air conditioner must be stored in a room without continuously operating ignition sources (e.g. open flames, an operating gas appliance or and an electric heater). Under no circumstances should this air conditioner be stored in a server room or any other similar environment.</li> </ul>
<ul style="list-style-type: none"> <li>Do no use means to accelerate the defrosting process or to clean, other than those recommended by the manufacturer.</li> </ul>
<ul style="list-style-type: none"> <li>Never touch the refrigerant piping or compressor without wearing gloves to avoid scald or frostbite.</li> </ul>









<b>Installation Notes</b>
<ul style="list-style-type: none"> <li>The air conditioner is not allowed to be used in a room that has a running fire (Such as fire source, working coal gas ware, operating heater, server room etc)</li> </ul>
<ul style="list-style-type: none"> <li>The air conditioner must be installed in a room that is larger than the minimum room area. ( See table pg.12 )</li> </ul>



## 1 General safety precautions

### 1.1 About the documentation

- The precautions described in this document cover very important topics, follow them carefully.

#### 1.1.1 Meaning of warnings and symbols

	<b>DANGER</b> Indicates a situation that results in death or serious injury.
	<b>DANGER: RISK OF ELECTROCUTION</b> Indicates a situation that could result in electrocution.
	<b>DANGER: RISK OF BURNING</b> Indicates a situation that could result in burning because of extreme hot or cold temperatures.
	<b>DANGER: RISK OF EXPLOSION</b> Indicates a situation that could result in explosion.
	<b>WARNING</b> Indicates a situation that could result in death or serious injury.
	<b>WARNING: FLAMMABLE MATERIAL</b>
	<b>CAUTION</b> Indicates a situation that could result in minor or moderate injury.
	<b>NOTICE</b> Indicates a situation that could result in equipment or property damage.
	<b>INFORMATION</b> Indicates useful tips or additional information.

Symbol	Explanation
	Before installation, read the installation and operation manual, and the wiring instruction sheet.
	Before performing maintenance and service tasks, read the service manual.
	For more information, see the installer and user reference guide.

## 1.2 For the user

- This appliance can be used by children aged from 8 years and above and persons with reduced physical, sensory or mental capabilities or lack of experience and knowledge if they have been given supervision or instruction concerning use of the appliance in a safe way and understand the hazards involved. Children shall not play with the appliance. Cleaning and user maintenance shall not be made by children without supervision.

	<b>WARNING</b> To prevent electric shocks or fire: <ul style="list-style-type: none"> <li>Do NOT rinse the unit.</li> <li>Do NOT operate the unit with wet hands.</li> <li>Do NOT place any objects containing water on the unit.</li> </ul>
---	---

	<b>NOTICE</b> <ul style="list-style-type: none"> <li>Do NOT place any objects or equipment on top of the unit.</li> <li>Do NOT sit, climb or stand on the unit.</li> </ul>
---	--

- Units are marked with the following symbol:



This means that electrical and electronic products may not be mixed with unsorted household waste. Do NOT try to dismantle the system yourself: the dismantling of the system, treatment of the refrigerant, of oil and of other parts must be done by an authorized installer and must comply with applicable legislation. Units must be treated at a specialized treatment facility for reuse, recycling and recovery. By ensuring this product is disposed of correctly, you will help to prevent potential negative consequences for the environment and human health. For more information, contact your installer or local authority.

- Batteries are marked with the following symbol:



This means that the batteries may not be mixed with unsorted household waste. If a chemical symbol is printed beneath the symbol, this chemical symbol means that the battery contains a heavy metal above a certain concentration. Possible chemical symbols are: Pb: lead (>0.004%). Waste batteries must be treated at a specialized treatment facility for reuse. By ensuring waste batteries are disposed of correctly, you will help to prevent potential negative consequences for the environment and human health.

## 1.3 For the installer

### 1.3.1 General

	<b>NOTICE</b> Improper installation or attachment of equipment or accessories could result in electric shock, short-circuit, leaks, fire or other damage to the equipment. Only use accessories, optional equipment and spare parts made or approved by EcoAir.
---	--

# Safety Precautions



## CAUTION

Wear adequate personal protective equipment (protective gloves, safety glasses,...) when installing, maintaining or servicing the system.



## WARNING

Tear apart and throw away plastic packaging bags so that nobody, especially children, can play with them. Possible risk: suffocation.



## CAUTION

Do NOT touch the air inlet of the unit.



## NOTICE

- Do NOT place any objects or equipment on top of the unit.
- Do NOT sit, climb or stand on the unit.

In accordance with the applicable legislation, it might be necessary to provide a logbook with the product containing at least: information on maintenance, repair work, results of tests, stand-by periods,...

Also, at least, following information must be provided at an accessible place at the product:

- Instructions for shutting down the system in case of an emergency
- Name and address of fire department, police and hospital
- Name, address and day and night telephone numbers for obtaining service

In Europe, EN378 provides the necessary guidance for this logbook.

## 1.3.2 Installation site

- Provide sufficient space around the unit for servicing and air circulation.
- Make sure the installation site withstands the unit's weight and vibration.
- Make sure the area is well ventilated. Do NOT block any ventilation openings.
- Make sure the unit is level.

Do NOT install the unit in the following places:

- In potentially explosive atmospheres.
- In places where there is machinery that emits electromagnetic waves. Electromagnetic waves may disturb the control system, and cause malfunction of the equipment.
- In places where there is a risk of fire due to the leakage of flammable gases (example: thinner or gasoline), carbon fibre, ignitable dust.
- In places where corrosive gas (example: sulphurous acid gas) is produced. Corrosion of copper pipes or soldered parts may cause the refrigerant to leak.

## Instructions for equipment using R32 refrigerant

If applicable.



## WARNING

- Do NOT pierce or burn.
- Be aware that R32 refrigerant does NOT contain an odour.



## WARNING

The appliance shall be stored so as to prevent mechanical damage and in a well-ventilated room without continuously operating ignition sources (example: open flames, an operating gas appliance or an operating electric heater) and have a room size as specified below.



## WARNING

Make sure installation, servicing, maintenance and repair comply with instructions from Daikin and with applicable legislation (for example national gas regulation) and are executed only by authorised persons.

## Installation space requirements



## WARNING

If appliances contain R32 refrigerant, then the floor area of the room in which the appliances are installed, operated and stored must be larger than the minimum floor area defined in table below A (m<sup>2</sup>).

## To determine the minimum floor area

- Determine the total refrigerant charge in the system (= factory refrigerant charge ① + ② additional refrigerant amount charged).

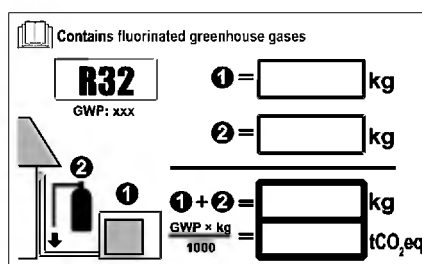

# Safety Precautions

Use the graph or table to determine the minimum floor area.

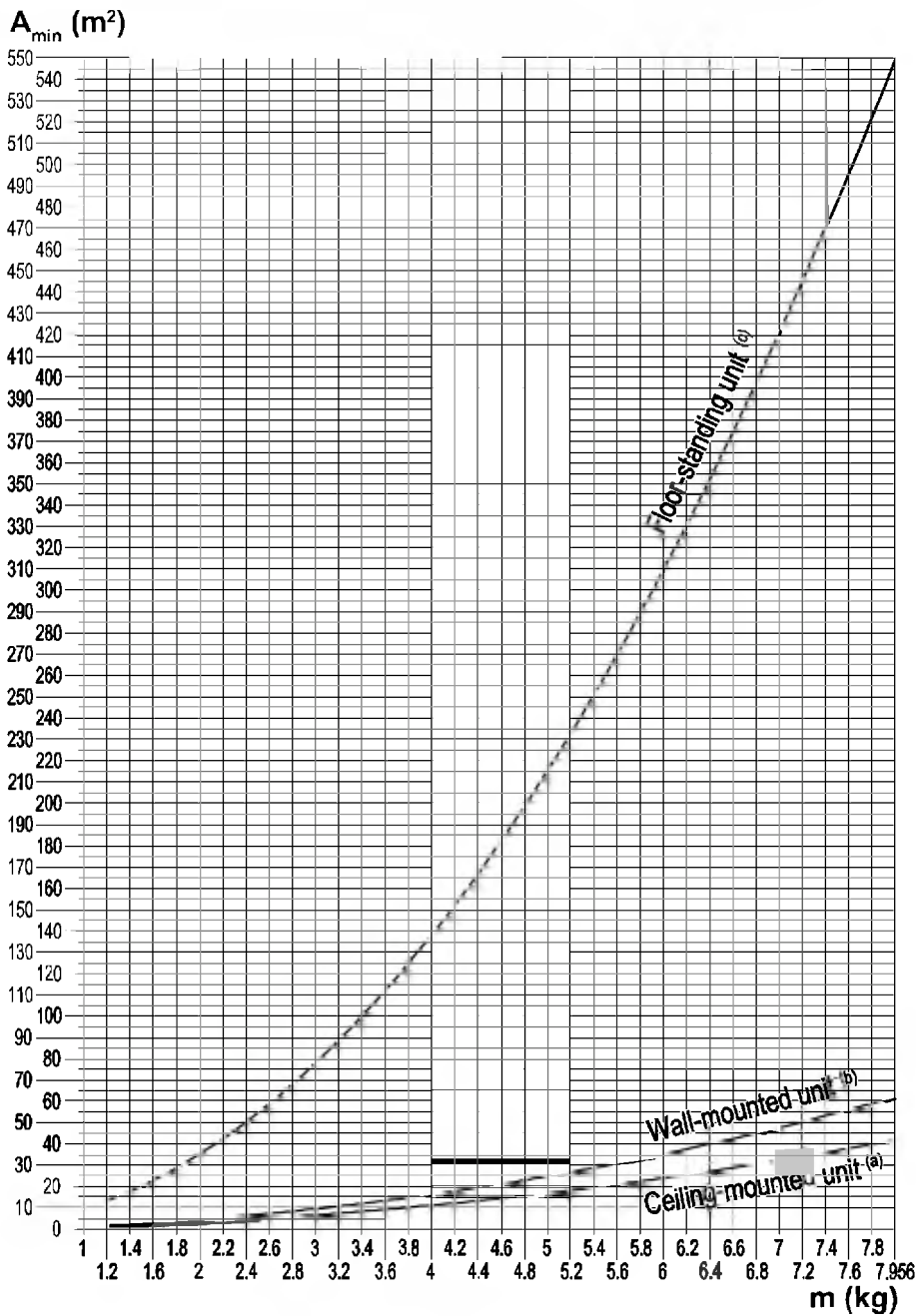

Floor-standing unit <sup>(c)</sup>	
m (kg)	A <sub>min</sub> (m <sup>2</sup> )
<1.224	—
1.225	12.9
1.4	16.8
1.6	22.0
1.8	27.8
2.0	34.3
2.2	41.5
2.4	49.4
2.6	58.0
2.8	67.3
3.0	77.2
3.2	87.9
3.4	99.2
3.6	111
3.8	124
4.0	137
4.2	151
4.4	166
4.6	182
4.8	198
5.0	215
5.2	232
5.4	250
5.6	269
5.8	289
6.0	309
6.2	330
6.4	351
6.6	374
6.8	397
7.0	420
7.2	445
7.4	470
7.6	496
7.8	522
7.956	549

- m** Total refrigerant charge in the system
- A<sub>min</sub>** Minimum floor area
- (a)** Ceiling-mounted unit (= Ceiling-mounted unit)
- (b)** Wall-mounted unit (= Wall-mounted unit)
- (c)** Floor-standing unit (= Floor-standing unit)

## Refrigerant



### WARNING

During tests, NEVER pressurize the product with a pressure higher than the maximum allowable pressure (as indicated on the nameplate of the unit).



### WARNING

Take sufficient precautions in case of refrigerant leakage. If refrigerant gas leaks, ventilate the area immediately. Possible risks:

- Excessive refrigerant concentrations in a closed room can lead to oxygen deficiency.
- Toxic gas may be produced if refrigerant gas comes into contact with fire.

## Electrical



### DANGER: RISK OF ELECTROCUTION

- Do NOT touch electrical components with wet hands.
- Do NOT leave the unit unattended when the service cover is removed.



## FRONT

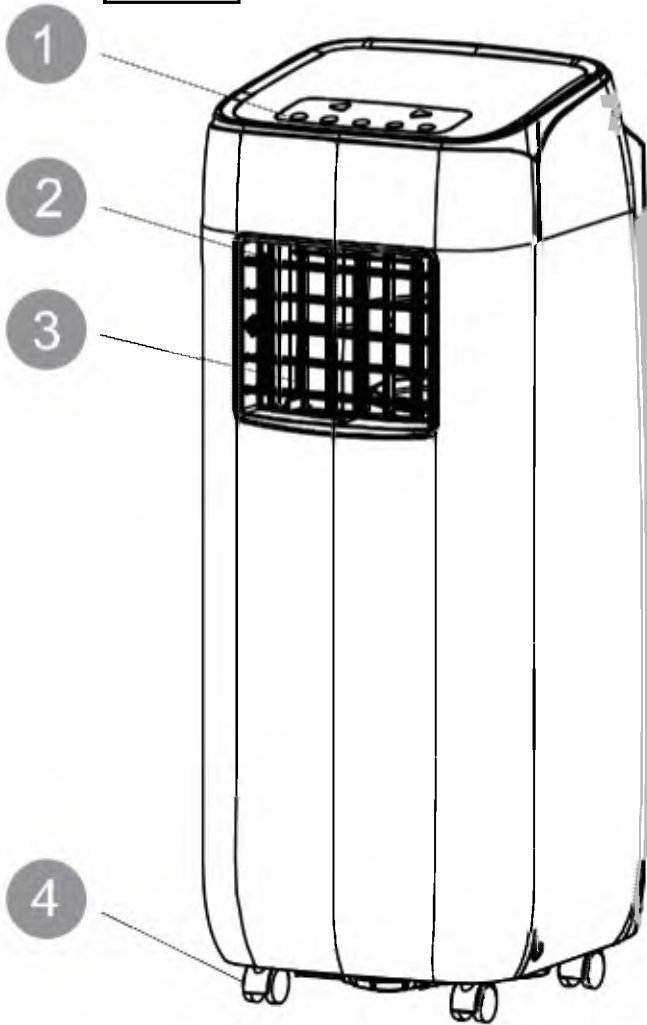

1. Control panel
2. Guide louvre (manual)
3. Swing louvre (manual)
4. Castor
5. Filter
6. Joint A
7. Discharge pipe
8. Joint B+C (see page 13, step 2)
9. Plug of power cord
10. Power cord hanger

## REAR

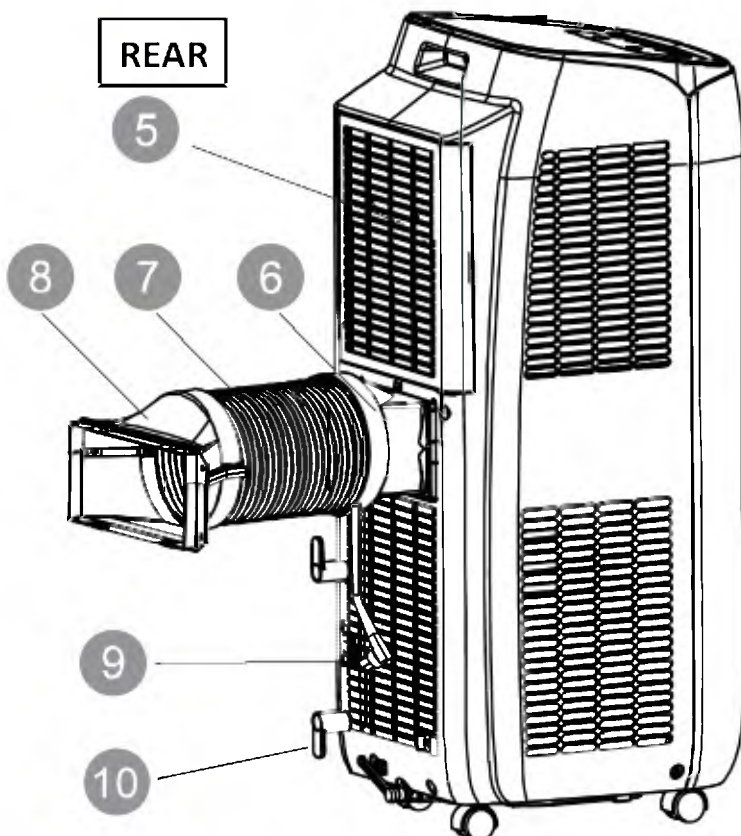





Remote Control

# INSTALLATION





**Note:** check if the accessories are available before installation.

## PACKAGE CONTAINS

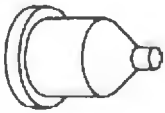

### Exhaust Kit

			
joint A	joint B	joint C	discharge pipe





### Drainage Kit

					
pipe clamp	rubber plug	pipe clip	bottom drainage pipe	drainage connector	screw included

### Others

	
power lead hook (2)	remote control

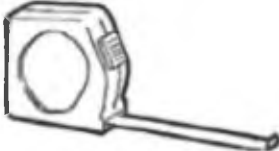
## TOOLS NEEDED FOR INSTALLATION

		
cross screwdriver	straight screwdriver	saw
		
measurement tape	scissors	pencil

# INSTALLATION

## INSTALLATION OF POWER LEAD HOOK

### STEP 1. ASSEMBLE THE POWER LEAD HOOK AT THE BACK OF THE APPLIANCE

Use screws to fix the power lead hook at the back of the appliance as shown below.

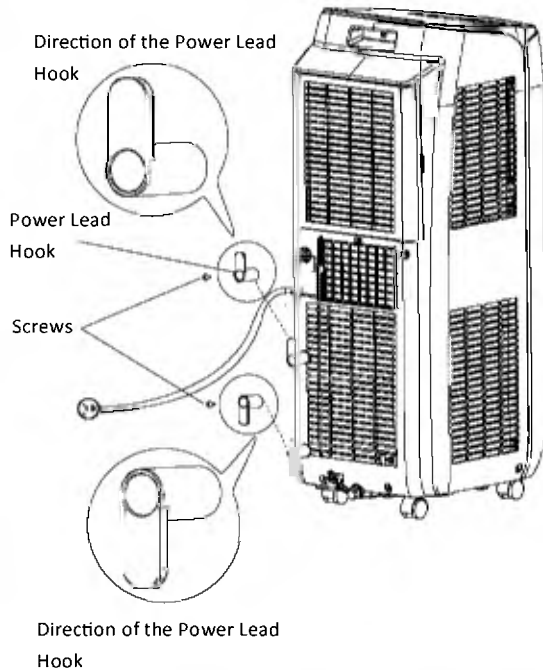

### STEP 2. WIND THE POWER LEAD AROUND THE HOOK

When you are not using the appliance wind the power lead around the hook as shown below.

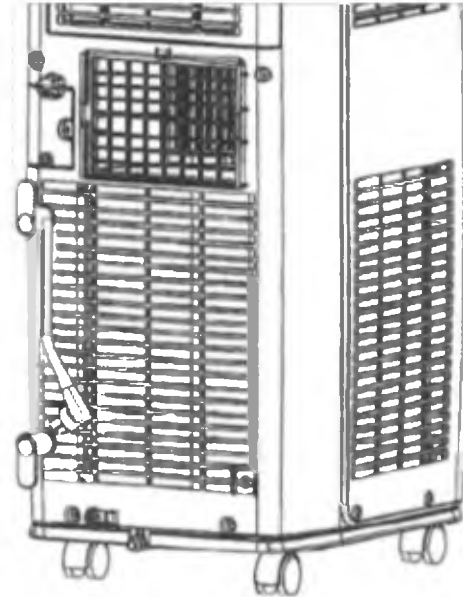

## INSTALLATION OF DRAINAGE

### BOTTOM DRAINAGE PORT FOR USE BEFORE STORAGE & WHEN FULL TANK LIGHT IS ON

\* Before Storage we recommend you drain the internal storage tanks using this drainage port.

**STEP 1.** Remove the rubber plug from the bottom drainage port.

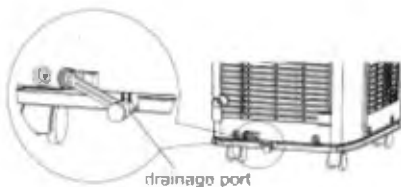

**STEP 2.** Attach the drain hose pipe clamp to the back panel of the appliance near the bottom drainage port with the screw provided.

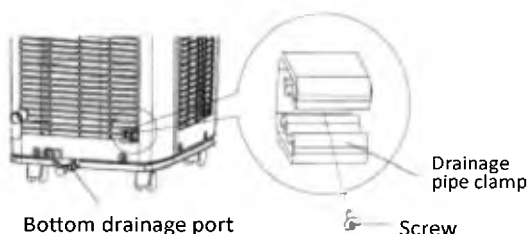

**STEP 3.** Attach one end of the drainage pipe to the drainage port with the pipe clip.

Make sure the hose is fully inserted into the drainage port.

Put the rubber plug into the other side of drainage pipe, fix it with pipe clip and then fix it into the drainage pipe clamp.

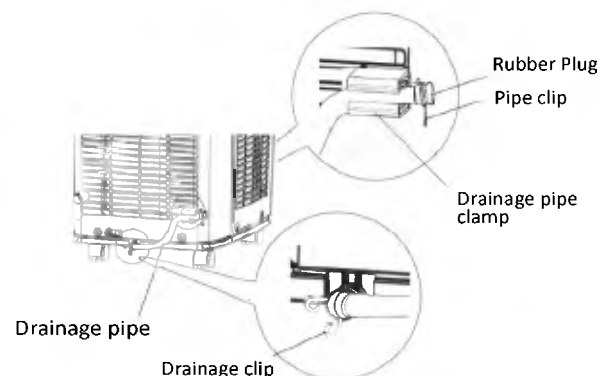

## INSTALLATION OF CONTINUOUS DRAINAGE

### CONTINUOUS DRAINAGE FROM MIDDLE DRAINAGE PORT

Water can be automatically emptied from the middle drainage port with a 14mm inner diameter hose (Not included in the package) which can be ordered from our website:

[www.ecoair.org](http://www.ecoair.org)

**STEP 1.** Remove the continuous drainage cap by turning it counter clockwise then remove the rubber plug from the middle drainage port.

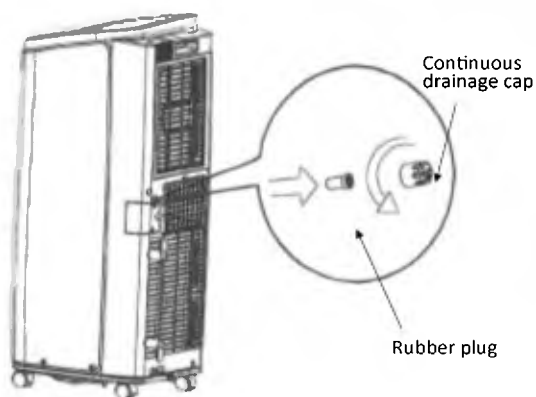

\* Store both the cap and plus safely for use when not in continuous drainage mode

**STEP 2.** Screw the drain connector to the drainage port by turning clockwise.

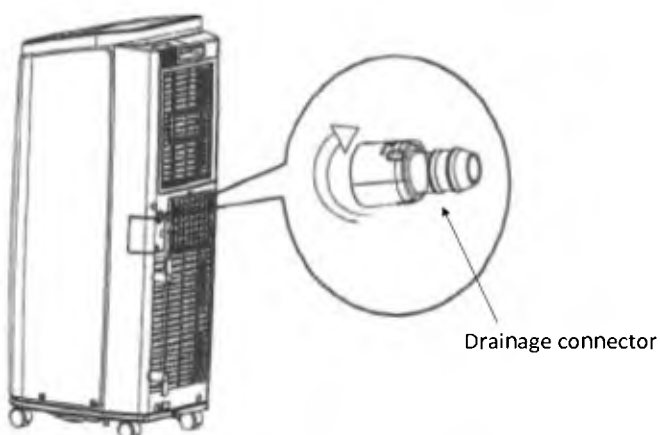

**STEP 3.** Insert the drainage hose (14mm) into the drainage connector.

Make sure the drainage hose goes downward from the middle drainage port.

The end of the drainage hose should not be outside when temperature is below 1°C.

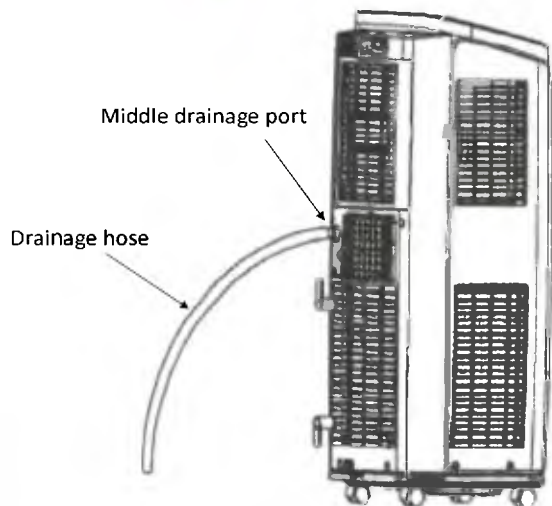

**NOTE:** When using continuous drainage option;

- ◆ Place the appliance on a level surface
- ◆ Make sure the continuous drainage hose is clear of any obstructions.
- ◆ The drainage hose should be placed downwards from the drainage ports.
- ◆ Do not bend or kink the drainage hose.

**IF ABOVE NOT FOLLOWED, APPLIANCE CAN LEAK WATER!**

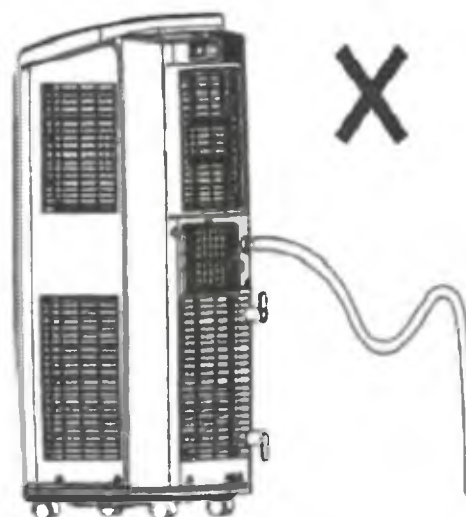

## WARNING

- ◆ Two or more people are required to move and install the appliance.
- ◆ Failure to do so may result in back or other injuries.

Do not pull the appliance along by the power cord. See Fig 1.

Do not place objects on the appliance or restrict air inlet / outlet. See Fig 2.

Do not use the appliance in humid or wet environment. See Fig 3.

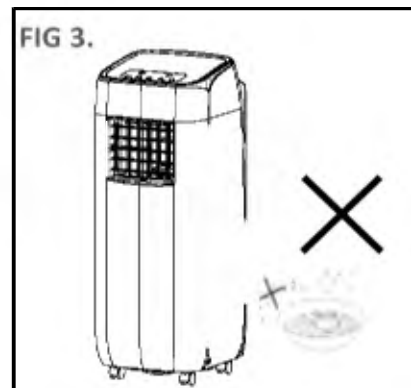
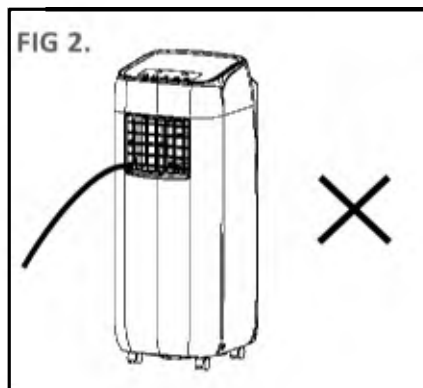
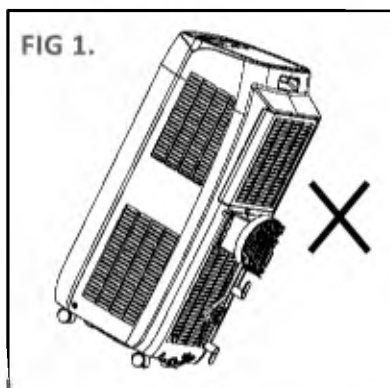

## INSTALLATION REQUIREMENTS:

- ◆ The appliance shall be installed in accordance with national wiring regulations.
- ◆ The appliance is for indoor use only, but should not be installed in a high humidity area (i.e. laundry room or wet room).
- ◆ Place the appliance on a smooth level floor that is strong enough to support the unit.
- ◆ Allow at least 50cm of air space on all sides of the appliance for good ventilation.
- ◆ Place the appliance in an area where the temperature will not fall below 16°C. Otherwise the coils will be covered with frost at temperatures below 16°C and this may reduce performance.

### Note:

The appliance has castors for easy movement.

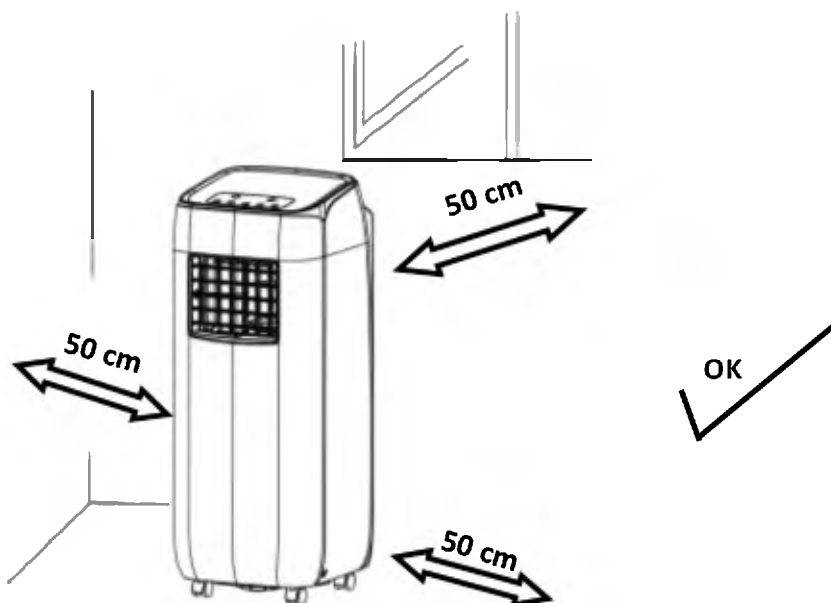

## INSTALLATION OF DISCHARGE PIPE

### STEP 1. CONNECT JOINT "A" TO DISCHARGE PIPE

Attach Joint A to discharge pipe

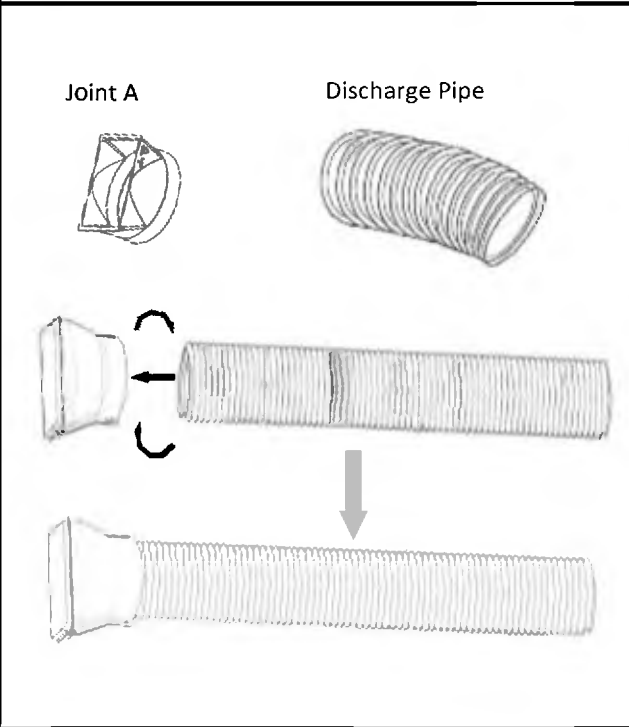

### STEP 2. CONNECT JOINT "B" & "C" TO DISCHARGE PIPE

Connect together Joint B to Joint C

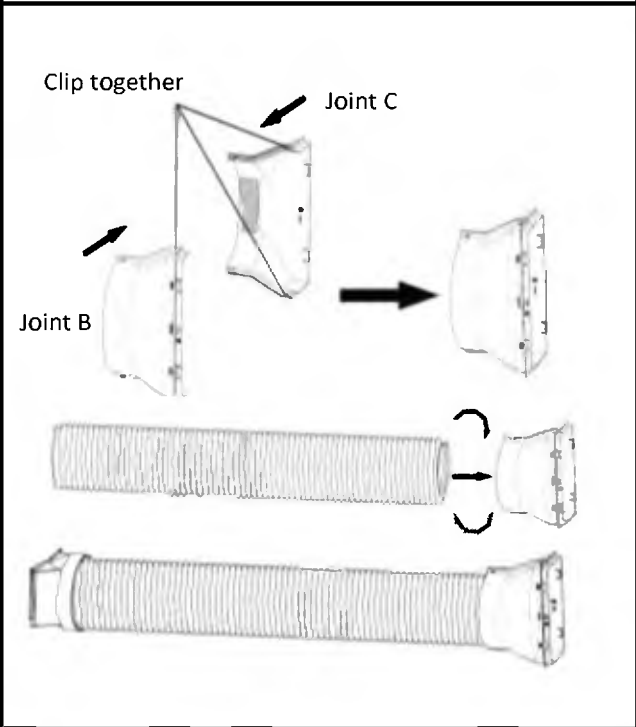

### STEP 3. CONNECT DISCHARGE PIPE TO APPLIANCE

Slide down Joint A to the air outlet

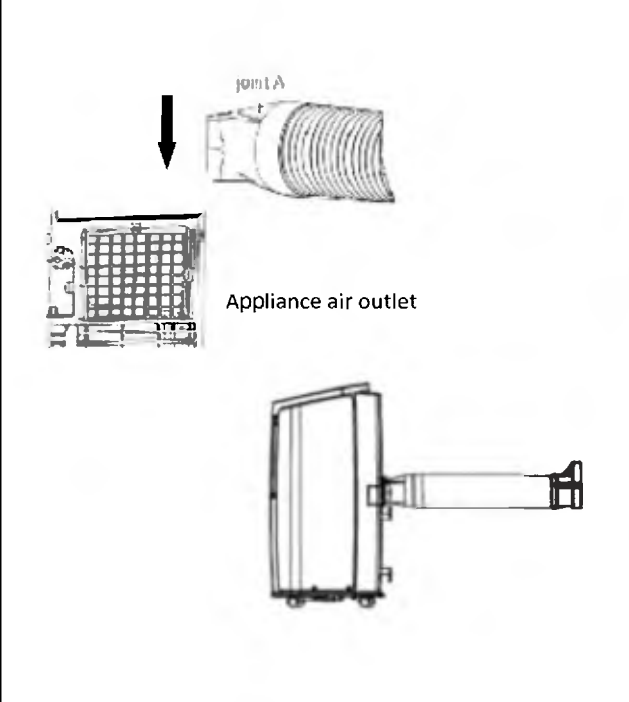

### STEP 4. DISCHARGE PIPE THROUGH THE WALL

1. Put a 150mm whole through the wall. (outer diameter 142mm)
2. Insert the discharge pipe through the hole.
3. Seal the gap between the wall and the discharge pipe.

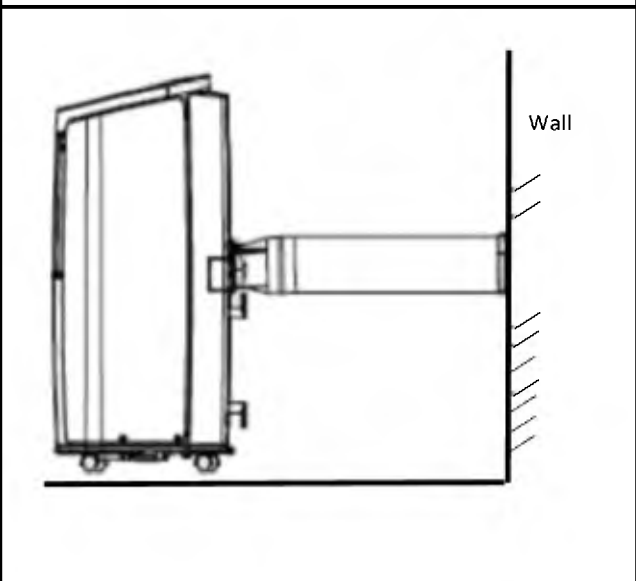



## INSTALLATION OF DISCHARGE PIPE

### STEP 5. DISCHARGE PIPE THROUGH A WINDOW GAP

1. Open the window and place the discharge pipe between the window frame and the window.
2. Seal the gap with a foam (not supplied) to prevent the hot air coming back into the room.

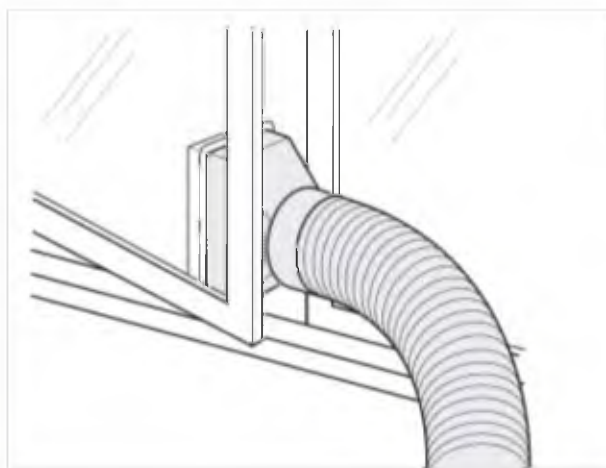
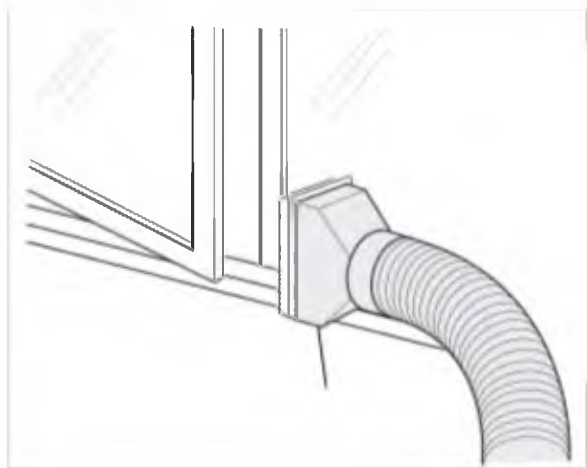

### STEP 5. DISCHARGE PIPE CONNECTION

In order to improve cooling efficiency, make sure the discharge pipe is as short and straight as possible.

Do not joint any other discharge pipe to the original pipe.

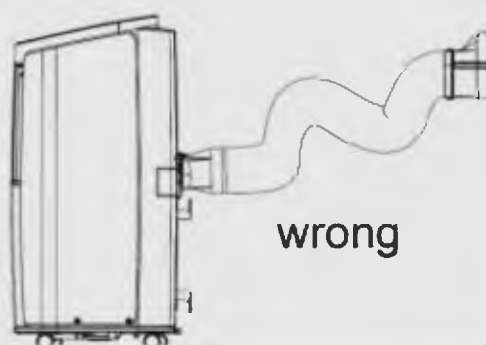
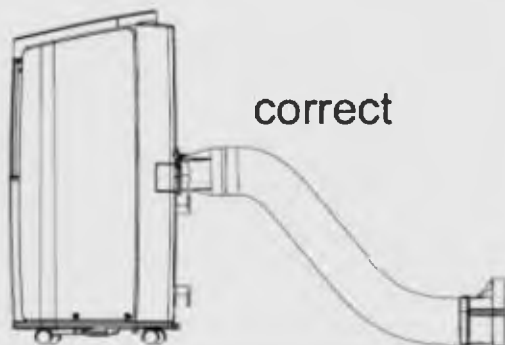
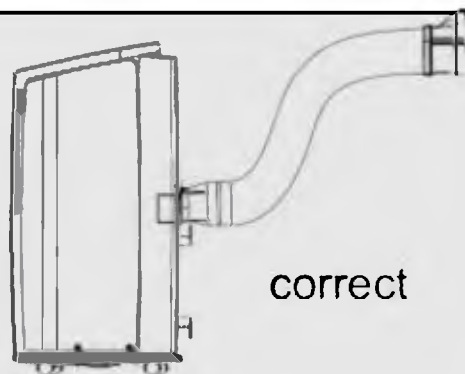
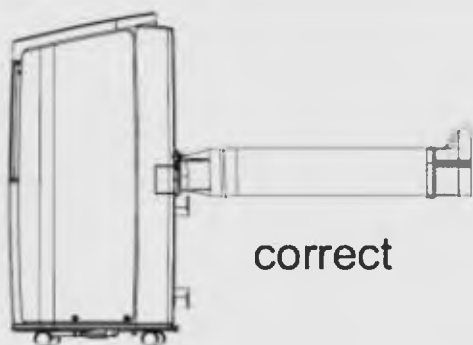

## DRAIN WATER FROM APPLIANCE

### DRAIN WATER FROM BOTTOM DRAINAGE PORT

During cooling mode, the appliance requires water drainage from the bottom drainage port. This will be indicated as an "H8" error. (see troubleshooting on page 18)

1. Remove the drainage pipe from the drainage pipe clamp and release the excess water by removing the rubber plug.
2. Drain the water out completely and the appliance should resume operation. Secure the plug and hose back into position.
3. Drain water completely before storage to avoid internal odours and mould.

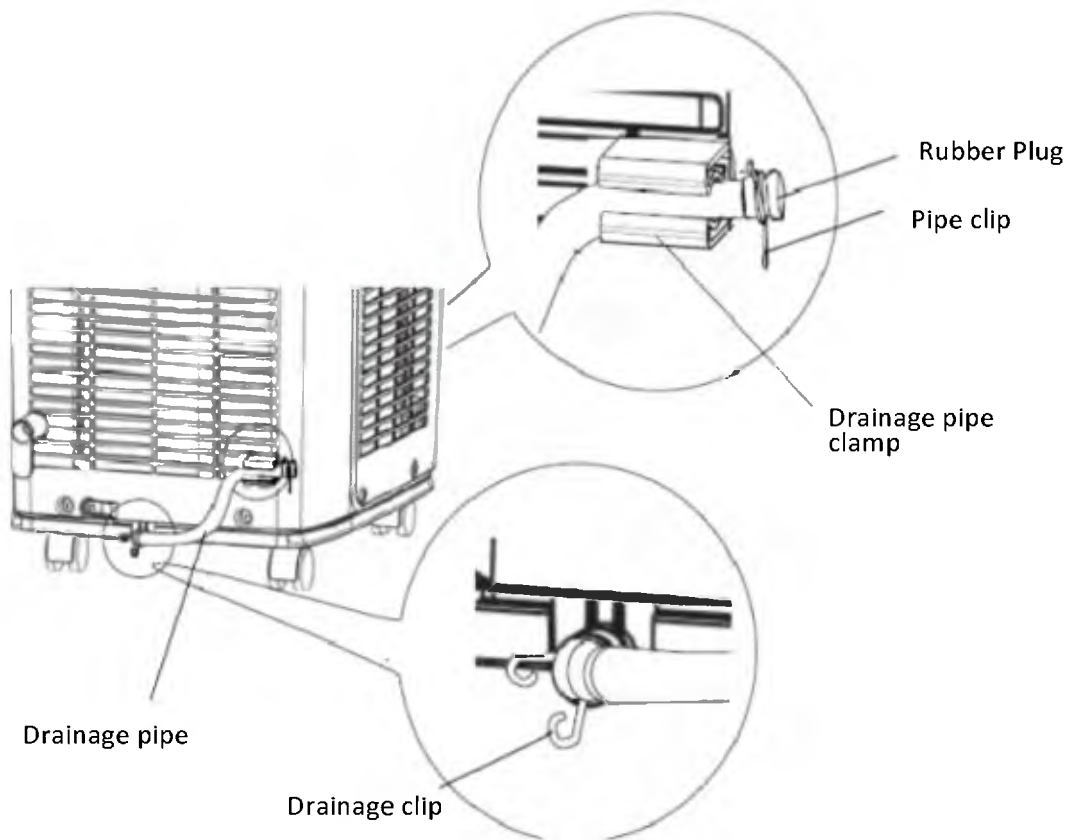



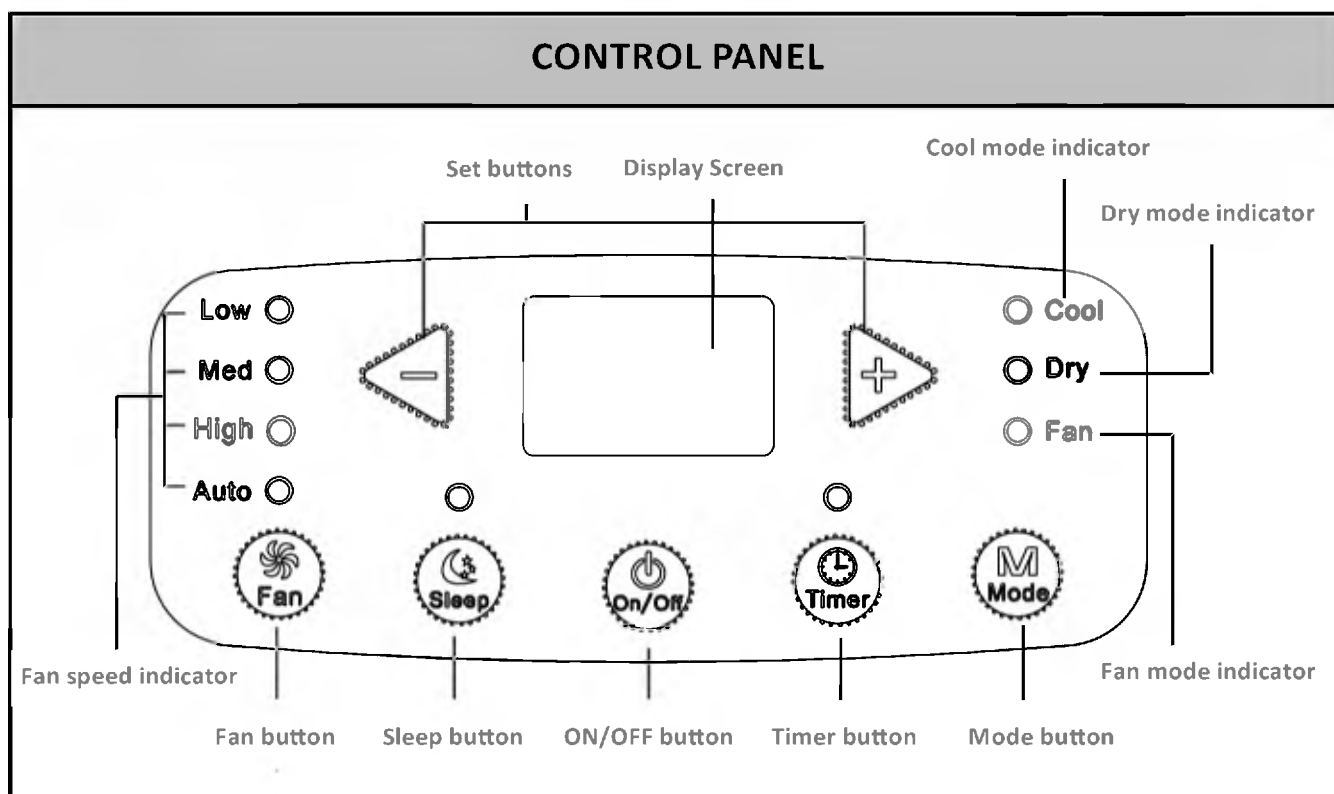

- ◆ After switching **ON**, the appliance will respond with a beep sound. After that, you can operate the appliance with the control panel or remote control.
- ◆ Under **ON** status, when pressing any button on control panel, the appliance will give out a sound. Meanwhile, corresponding indicator light on control panel will be on.
- ◆ Under **OFF** status, there is no display on the control panel.
- ◆ Under **ON** status, the set temperature will show on the display control panel only in cooling mode.
- ◆ For any other modes, the display will not show the temperature.

## ON / OFF BUTTON



Press the ON/OFF button to switch on and off.

## MODE BUTTON



Press this button to select : COOL ► DRY ► FAN

**COOL:** When cooling Mode indicator is on, the appliance will operate in cooling mode. Display shows the set temperature.

**DRY:** When drying Mode indicator is on, the display shows nothing. Appliance will operate at low speed only.

**FAN:** When fan mode indicator is on, the display shows nothing. The appliance only blows air in the ambient temperature as a fan does.

## SET BUTTONS



Under cooling mode, press "+" or "-" button to increase or decrease set temperature by 1 °C.

Set temperature range is between 16°C - 30°C. Under auto, drying or fan mode, this button is invalid.

## FAN BUTTON



Press this button to select:



- ◆ Auto
- ◆ Low
- ◆ Medium
- ◆ High

These fan speeds can be selected in cooling and fan modes only.

## TIMER BUTTON



- ◆ When unit is on, press the timer button to set Timer Off. T-OFF and H icon will be blinking. Within 5s, press ◀ or ▶ button to adjust the time for Timer Off. Pressing ◀ or ▶ button once will increase or decrease the time by 0.5h. Holding ◀ or ▶ button for 2s, time will change quickly. Release the button after your required setting time is reached. Then press TIMER button to confirm it. T-OFF and H icon will stop blinking.
- ◆ When unit is off, press this button to set Timer On. T-ON and H icon will be blinking. Within 5s, press ◀ or ▶ button to adjust the time for Timer On. Pressing ◀ or ▶ button to adjust the time for Timer On. Pressing ◀ or ▶ button once will increase or decrease the time by 0.5h. Holding ◀ or ▶ button for 2s, time will change quickly. Release the button after your required setting time is reached. Then press TIMER button to confirm it. T-ON and H icon will stop blinking.
- ◆ Cancel timer ON/OFF: If Timer function is set up, press TIMER button once to review the remaining time. Within 5s, press TIMER button again to cancel this function.

## SLEEP BUTTON



Press this button to select sleep mode. (Works in Cooling and Dry Mode only)

- ◆ The preset temperature will increase by 1°C after the first hour.
- ◆ The preset temperature will increase by 2°C after two hours. The appliance will operate in this temperature until it is switched off.
- ◆ Use this mode for bedtime, the appliance will reduce the cooling as you fall asleep since our body temperature tends to come down during that period.

## REMOTE CONTROL

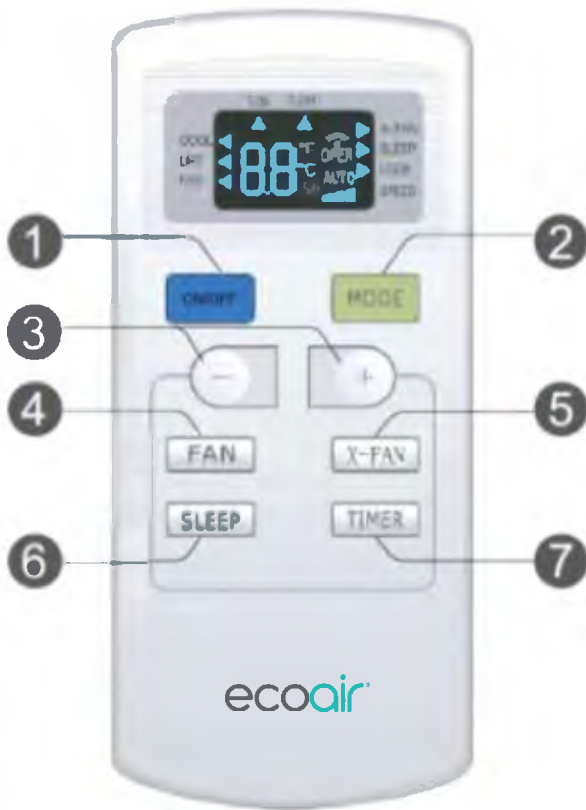

1. ON / OFF button
2. MODE button
3. SET buttons
4. FAN button
5. X-FAN button
6. SLEEP button
7. TIMER button

**Note:**

- ◆ Press MODE and " - " buttons at the same time to switch between °C and °F. (while the appliance is switched off)
- ◆ Press " + " and " - " buttons at the same time to switch ON and OFF CHILD LOCK.

### USEFUL INFORMATIONS

- ◆ During the operation, point the remote control towards the appliance not more than 6 meters away.
- ◆ Make sure there is no obstacles between the remote control and the appliance.
- ◆ Remote control signal may be interfered within the room where there is wireless telephone, fluorescent lamp.
- ◆ When appliance is not in use for a long time, please remove batteries.
- ◆ If there is no display on the remote control, please replace batteries.

## REMOTE CONTROL DISPLAY SCREEN

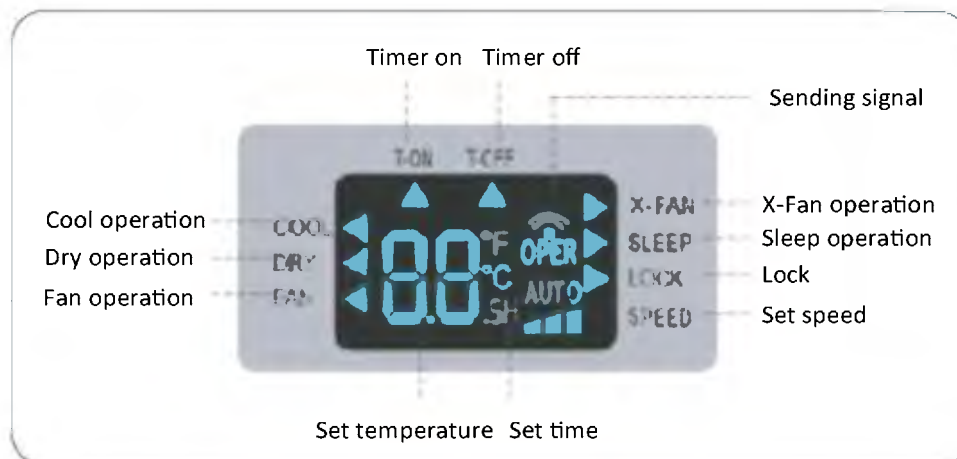

## X-FAN BUTTON

X-FAN

Press this button to switch ON and OFF the X-fan mode under cooling and dry modes.

This mode air dries the inside of the appliance when it is switched off so that the fan will continue to operate at low speed for a few minutes before switching off.

When X-fan mode is OFF, the fan will stop immediately upon switching off.

**Note:** Regular use of X-fan mode reduces condensation within the appliance, which can cause mould and musty smell build-up.

## AIR FLOW DIRECTIONS

### HORIZONTAL DIRECTION

Hold the horizontal louvres and move up or down for your comfort.

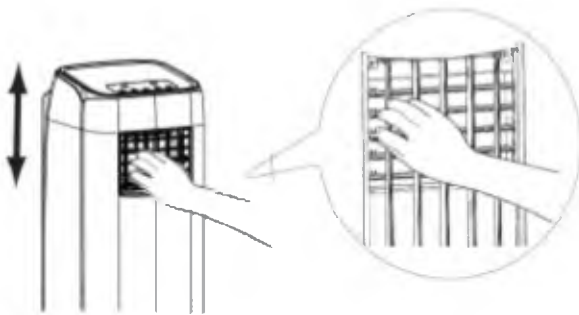

### VERTICAL DIRECTION

Hold the vertical louvres and move left or right.

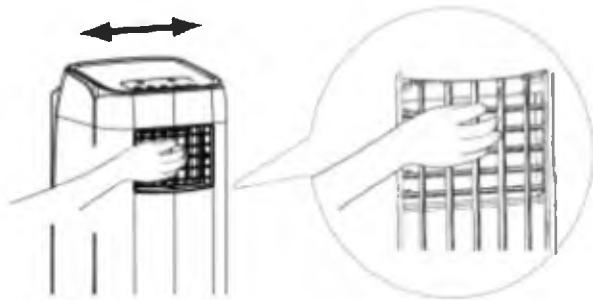

**NOTE:** Do not close the air flow completely.

## REPLACING BATTERIES

1. Gently pull clip back on the battery cover to remove.
2. Replace two (AAA 1.5V) dry batteries and make sure the positions of plus and minus poles are correct.
3. Re-attach the cover of battery box.

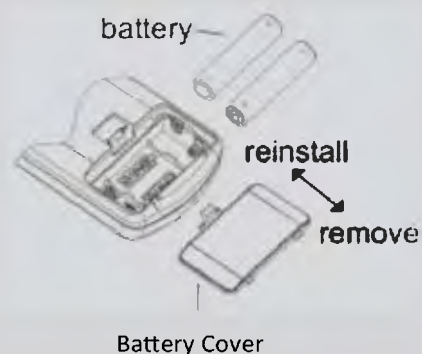

# CLEANING AND MAINTENANCE

## NOTE:

- Before cleaning the appliance, turn it off and disconnect power. Otherwise, it may cause electric shock.
- Do not wash appliance with water. Otherwise, it may cause electric shock.
- Do not use volatile liquid (such as thinner or gas) to clean the appliance. Otherwise, it may damage the appearance of appliance.

### Clean outer case:

If there's dust on the surface of outer case, use soft towel to wipe it.

If the outer case is very dirty, use a damp cloth to clean it.

### Clean grille:

Use soft brush or cloth to clean it.

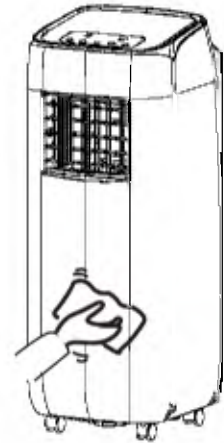

## CLEAN FILTER

### 1. REMOVE THE FILTER

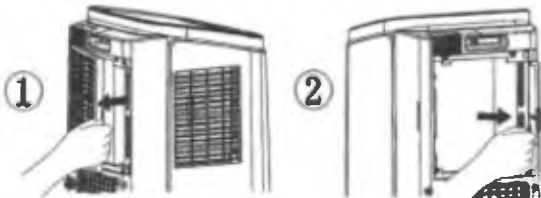

### 3. INSTALL FILTER

Before re-installing the filter, make sure the filter is dry.

### 2. CLEAN FILTER

Use vacuum cleaner, brush or water to clean the filter.

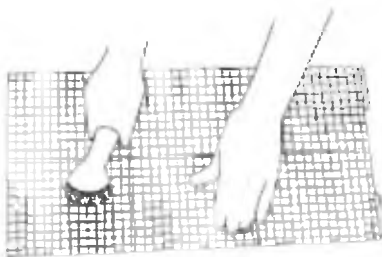

### 3. USEFUL INFORMATION

The filter should be cleaned at least once every two weeks. For dusty environment, you should increase the cleaning frequency.

## STORAGE OF THE APPLIANCE

Please follow the following steps for optimum performance:

1. Disconnect power supply and wrap the power cord.
2. Clean filter and outer case.
4. Drain the water from the appliance.
5. Make sure discharge pipe is disassembled.
6. Clean the appliance and pack it well to prevent dust.

## TROUBLESHOOTING

CHECK THE FOLLOWING POINTS BEFORE CONTACTING TECHNICAL SUPPORT.

### MALFUNCTION CODES

<b>E5</b>	Overcurrent protection.	Disconnect power, and then turn on the appliance again after 10 min.
<b>H8</b>	Internal water tank is full.	Drain the water from bottom drainage port.
<b>F1</b>	Malfunction of ambient temperature sensor.	Check the appliance is within the operating temperature.
<b>F2</b>	Malfunction of evaporator temperature sensor.	Check the appliance is within the operating temperature.
<b>H3</b>	Overload protection for compressor	<ul style="list-style-type: none"> <li>◆ Check the appliance is within operating temperature and not in high-humidity environment; if ambient temperature is more than 35°C, switch off the appliance and then switch on when the ambient temperature less than 35°C.</li> </ul>
<b>E8</b>	Overload malfunction	<ul style="list-style-type: none"> <li>◆ Make sure the filters are clean.</li> </ul>
<b>F0</b>	Temperature or humidity is very low	<ul style="list-style-type: none"> <li>◆ Increase the room temperature</li> <li>◆ Switch off the appliance until the humidity rises again</li> </ul>

PROBLEM	REASON	SOLUTION
The Appliance does not SWITCH ON	The power supply is not connected properly.	Check the power supply connection or try in a different power socket.
	The power plug is not inserted correctly.	Insert the power plug correctly.
	The power socket is faulty or fuse blown in the plug.	Change the fuse.
Poor Cooling	Filter might be dirty.	Clean the air filter.
	Set temperature might be incorrect	Check the set temperature. (should be below the ambient temperature)
	Windows and doors are open.	Close the doors and windows.
	Discharge pipe longer than recommended.	<ul style="list-style-type: none"> <li>◆ Change it to the recommended length (max 1.5 meter)</li> <li>◆ Keep the discharge pipe short and as straight as possible</li> </ul>
Appliance cannot receive signal from controller Or Remote Control is not sensible	Remote control is outside of range.	Use the remote control within 6 meter range.
	Remote control signal blocked by obstacles.	Move away the obstacles.
	Appliance does not respond to the remote control.	Replace the batteries.

PROBLEM	REASON	SOLUTION
Fan is not working	Air outlet or Air inlet is blocked.	Remove the blockage from air outlet and air inlet.
	Appliance is defrosting.	It is normal. Wait until the appliance finish defrosting.
	Appliance is not switched ON.	Switch ON the appliance.
Set Temperature cannot be adjusted	The appliance is on wrong mode.	Change it to cooling mode. (Fan and Dry mode cannot adjust temperature)
	Set temperature has been reached.	This is normal.
	Outside the set temperature range.	Temperature range is between 16°C - 30°C.
Bad Smell from Appliance	There is lot of smoke in the room, resent painting or building works.	<ul style="list-style-type: none"> <li>◆ Do not to use the appliance in this environment.</li> <li>◆ Clean the filters.</li> </ul>
	Water left in the appliance for a long time.	Drain the water from the appliance regularly.
Appliance is noisy	Not on even surface.	Keep the appliance on an even surface.
	Discharge pipe longer then recommended size.	Keep within the range.
	Discharge pipe not installed correctly.	Check the discharge pipe and install correctly.
Water Flowing sound from the appliance	Refrigerant flowing inside the appliance.	This is normal.

In the unlikely event of a problem with your product, please refer in the first instance to:

**ECOAIR TECHNICAL SUPPORT**

[www.ecoair.org/support](http://www.ecoair.org/support)



# SPECIFICATIONS

MODEL	CRYSTAL
Cooling capacity (BTU)	9000
Cooling capacity (W)	2640
Cooling power current (A)	4.5
Cooling Power Input (W)	1010
Air volume (L/M/H)	250/290/320 m <sup>3</sup> /h
Humidity removal capacity	1.43L/hour
Power supply	220-240V~50Hz
Sound pressure Level (L/M/H)	49/51/53 dB(A)
Refrigerant	R32(340g)
Fan speed	3
Timer	1~24 hours
Set range temperature	Cooling: 16°C ~ 30°C
Net weight	26.5 Kg
Gross weight	32 Kg
Net Dimension (W x H x D)	304mm x 800mm x 358mm
Gross Dimension (W x H x D)	365mm x 879mm x 493mm

EcoAir guarantees this product to be free from defects in materials and workmanship for a period of One (1) year from the date of purchase. Coverage is valid only with proof of purchase.

## Warranty Terms and Conditions

The conditions below apply to our warranty. They do not affect your statutory rights or the obligations of your retailer and your contract with them.

We provide warranty cover for this appliance subject to the following conditions:

1. We will rectify defects affecting the appliance which are clearly attributable to material and/or manufacturing faults, provided they are reported immediately after being identified within the Warranty Period supported by proof of purchase.
2. Service may not be available to all the islands around the UK. Please check with your retailer or contact our customer service department.
3. The warranty will not extend to consumables such as air filters.
4. Warranty liability will not be triggered by minor variances from nominal features which are of no significance to the appliance's value or fitness for purpose, nor damage caused by wear and tear, exceptional environmental conditions and inappropriate operating conditions.
5. No warranty liability will be accepted:-
  - a. If the defects stem from transport damage for which we are not responsible.
  - b. Improper installation and assembly or non-compliance with the safety regulations and warnings given in the operating instructions.
  - c. Improper use, to also include poor maintenance caused by insufficient aftercare or cleaning and failure to observe operating or assembly instructions or use with improper voltage recommendations.
  - d. Use in a non-domestic environment, to include air conditioner for rental.
6. No rights are given under this warranty to a person acquiring the appliance second hand.
7. We reserve the right to invalidate the warranty: -
  - a. If repairs or other interventions are performed by persons not authorised by us.
  - b. If our appliances are fitted with non-original spare parts, extras or accessories.
  - c. If our appliance has been altered and damaged by owner or third parties.
  - d. In the event of abuse (whether physical or verbal abuse) towards any member of staff.
8. Warranty provision will be free of charge and we will decide whether this will take the form of a repair or the replacement of the appliance. Small appliances that can be reasonably transported or posted may need to be handed over or shipped to our customer service centre. A purchase receipt must be presented in each case. Replaced parts pass into our ownership.
9. Under no circumstances shall the application of this warranty give rise to the complete replacement of the appliances. In the event of a replacement appliance being supplied at our discretion, we reserve the right to charge an appropriate monetary offset in respect of the period of use already enjoyed.
10. The provision of services under warranty neither extends the term of the warranty nor sets in motion a new Warranty Period. The Warranty Period for spare parts fitted ends with the expiry of the warranty on the appliance as a whole.
11. EcoAir shall not be liable for loss of goods, loss of use, or any special, indirect, consequential or pure economic loss, costs, damages, charges or expenses.
12. Our Warranty service is on a return to base basis.
13. This unit is only for domestic use.
14. The Customer acknowledges and agrees that details of the Customer's name, address and payment method will be held and used by EcoAir to provide the services and to send to the Customer further Information. EcoAir may disclose your information to third parties and agents in order to perform the services.

These warranty conditions apply to appliances purchased in the United Kingdom. If appliances shipped to other countries feature the appropriate technical conditions (e.g. voltage, frequency, gas-types etc.) for the climatic and environmental conditions in the country concerned, the terms of the warranty will apply, provided a local customer service network exists. Appliances purchased outside the United Kingdom are subject to the warranty conditions published by the appropriate local representative office of that country. These can be obtained via the specialist dealer from whom you bought appliance.

www.ecoair.org  
C425-18092019

ecoair®

