

VEBO

Compressor Dehumidifier

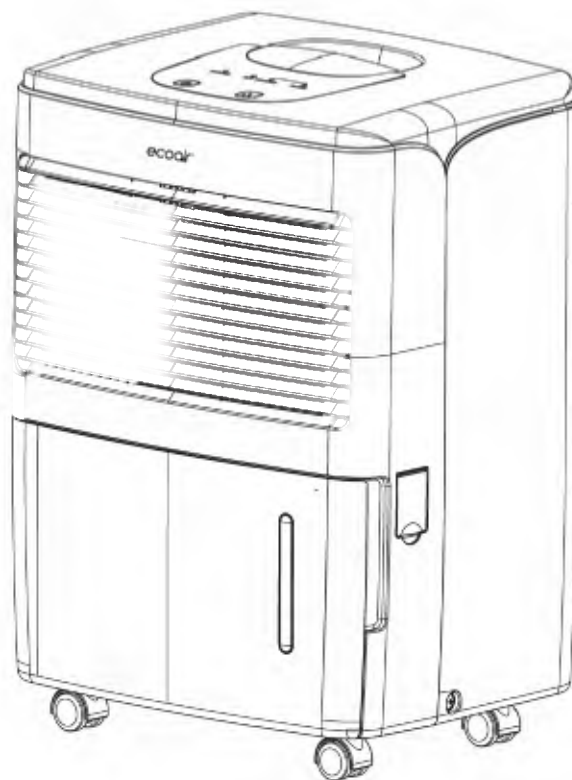

Congratulations!

You have purchased the very latest in dehumidification technology. Your new EcoAir high efficiency room appliance will give you many years of dependable service. Many features have been built into your EcoAir portable appliance to assure quiet operation, functional controls and the most economical operation.

BS Plug wiring	Page 3
Introduction	Page 4
Important Safety Instructions	Page 5
Key Features	Page 6
Quick Start Up	Pages 7 - 8
Empty Water Tank Instructions.....	Page 9
Continuous Drainage Instructions	Page 10
Maintenance	Page 11
Troubleshooting	Page 12
Specifications	Page 13
Guarantee Card	Page 14

When using this appliance in European countries, the following information must be observed:

Do not dispose of this product as unsorted waste.

It is prohibited to dispose of this appliance as domestic household waste. For disposal:

- Contact your local council
- The manufacturer will take back the old appliance for disposal when you replace it with a new product.
- Old products contain valuable resources, which should be recycled as scrap metal.



Wild disposal of waste in forests and landscapes endangers your health when hazardous substances leak into the ground-water and find their way into the food chain.

BS PLUG WIRING

Wiring Instructions: Should it be necessary to change the plug, please note the wires in the mains lead are coloured in accordance with the following codes:

BLUE - NEUTRAL
BROWN – LIVE
GREEN AND YELLOW - EARTH

In the event that the colours of the wires in the mains lead of this appliance does not correspond with the coloured markings identifying the terminals in your plug, proceed as follows:

1. The **BLUE** wire is **NEUTRAL** and must be connected to the terminal which is marked with the letter **N** or coloured **BLACK**.
2. The **BROWN** wire is **LIVE** and must be connected to the terminal which is marked with the letter **L** or coloured **RED**.
3. The **GREEN/YELLOW** is **EARTH** and must be connected to the terminal which is marked with the letter **E** or  or coloured **GREEN** or **GREEN/YELLOW**.
4. Always ensure that the cord grip is positioned and fastened correctly.

If a **13A (BS 1363)** fused plug is used it must be fitted with a **13A** -fuse. If in doubt consult a qualified electrician.

Wiring for a 13 Amp Plug (BS1363)

Please note. The Earth Terminal is marked with the letter **E** or  Earth Symbol.

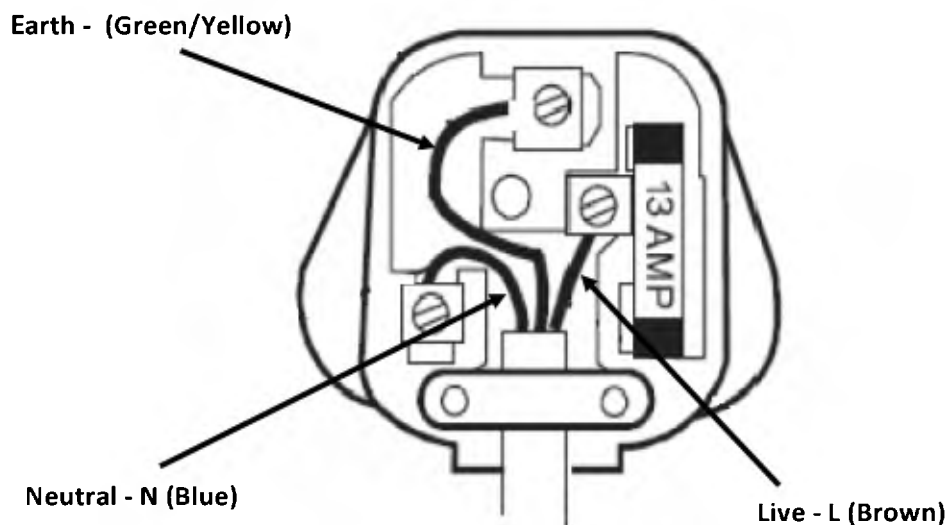

Introduction

Thank you and congratulations for choosing an EcoAir dehumidifier to help you control the Relative Humidity within your home. Inside this manual you will find many helpful tips on how to use and maintain your dehumidifier efficiently. Just a little preventative care can save you money and prolong the life of your dehumidifier.

The purpose of the dehumidifier is to remove the excess moisture in the air by detecting the humidity level in the room. By keeping humidity within recommended levels, a dehumidifier combats household damp, mould and mildew. Dehumidifiers can help to reduce the symptoms of asthma, allergies, and other respiratory health conditions. They can also be used to help dry laundry quicker and control moisture-based damage (such as the aftermath of flooding, leaks or rising damp) to valuable belongings and furniture.

HUMIDITY GUIDE

There will always be water vapour in the air. The water vapour (or commonly known as moisture) in the air is measured in % Relative Humidity (RH). RH is the ratio of the actual amount of water vapour in the air to the amount it could hold when saturated expressed as a percentage. Too much or too little moisture in our homes can be unhealthy and uncomfortable. The optimum humidity level is between 40% and 60% (RH) where we feel most comfortable.

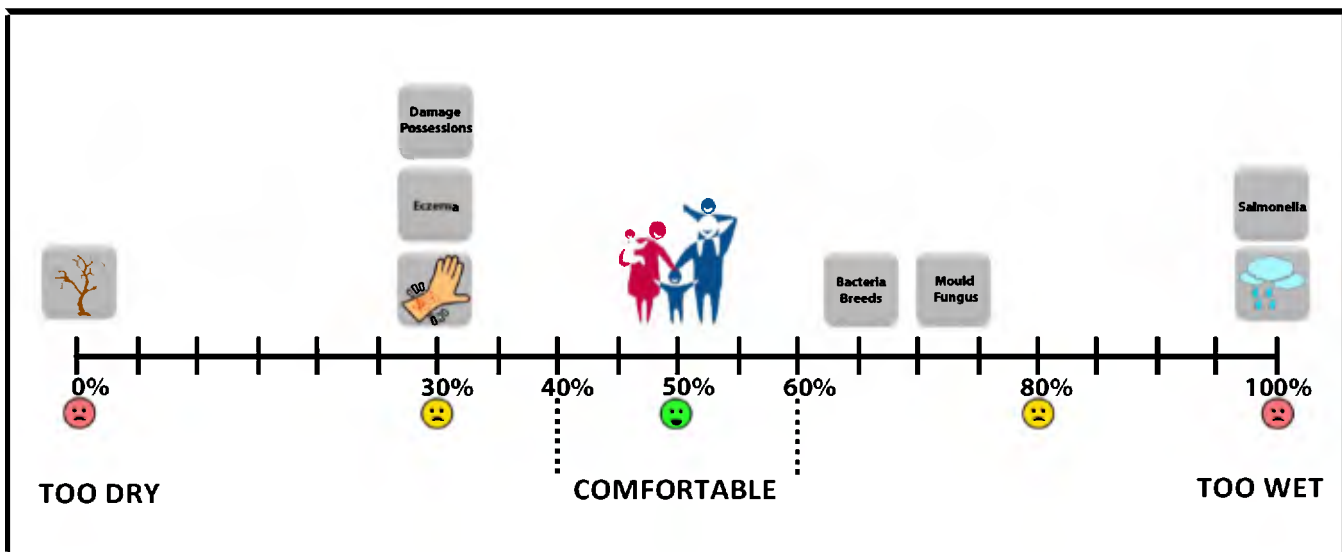

LOW HUMIDITY

Low humidity indoors causes excess drying which can trigger skin irritations such as eczema, chapped skin and dry nose. It can also damage possessions, such as wooden furniture, musical instruments and artwork by drying it out too much.

HIGH HUMIDITY

High humidity indoors causes damp and condensation. The damp left by condensation can damage plaster, wall paper, furniture, vehicles, timber windows, doors and clothes. It can be harmful to our health when bacteria thrives, causing mould and fungus.

MAINTAINING SAFE LEVELS OF HUMIDITY

It is important to maintain a consistent humidity range to preserve furniture, paintings, door and window frames. High humidity causes swelling, corrosion, softening of glues and paint. Low humidity causes shrinking, cracking, warping of wood surfaces and gaps in joints, doors and windows. Frequent changes in humidity levels can accelerate damages to property and belongings.

CONDENSATION

The warmer the air, the more moisture the air can hold than colder air. So, when the air inside the house becomes colder, the moisture contents in the air becomes saturated, and gets heavier resulting in moisture concentration on the coldest parts of the house particularly on the windows, bathroom mirrors and walls. This is condensation, caused by a sudden increase in humidity, cooking, showers, drying clothes, inadequate ventilation and poor thermal insulation.

Condensation does not disappear instantly even with the dehumidifier on. Where excessive condensation appears for example, on your windows, you may want to open your windows to expel the excess humidity for several minutes. It will take a while for the condensation to generally increase the humidity in the room. Once the humidity level in the room around the dehumidifier is increased above the level you have set on the dehumidifier, it will then begin the dehumidification process.

IMPORTANT SAFETY INSTRUCTIONS

PLEASE READ ALL INSTRUCTIONS CAREFULLY BEFORE OPERATING.

WARNING!

This appliance is intended for domestic use only. It is not suitable for outdoor use. Any other use is not recommended by the manufacturer and may cause fire, electrical shocks or other injuries to person or property. EcoAir cannot be held liable for damage resulting from incorrect or improper use or operation.

When using electrical appliances, basic safety precautions should always be followed:

1. Do not operate the appliance if there is a damaged cord, plug or after it malfunctions if it has been dropped or damaged in any way. Arrange for the appliance to be examined or repaired by an authorised technician.
2. Always keep the appliance in an upright position to avoid any damage. Place the appliance on an even level surface during operation.
3. Ensure the household voltage matches the rated specification for the appliance before use.
4. Operate this appliance in an ambient temperature between 16°C and 32°C.
5. Ensure that the air inlets and outlets are not blocked or covered. Do not insert fingers or any objects into the air inlet or outlet openings.
6. Do not place the unit too close to curtains or any other objects, keep minimum distance of 40cm.
7. Never place anything on top of the appliance and do not cover while in use.
8. To protect against electric shocks, do not immerse or spray the appliance or any of its parts in water.
9. Never unplug the power cord without switching OFF the appliance first.
10. Always unplug the appliance when not in use or when moving location. To disconnect the appliance from the power supply, grip the plug and pull from the power socket. Never pull by the cord.
11. Always empty the internal water tank before storing the appliance away.
12. Close supervision is necessary when the appliance is used in the presence of children and pets.
13. Do not run power cord under carpeting, or cover with rugs or runners. Arrange the cord away from areas where it may become a trip hazard.
14. Never operate or store the appliance in direct sunlight.
15. Repairs must be carried out by an authorised technician, failure to do so may cause damage to the appliance or injury to persons or property and will void the warranty. Always insist on original spare parts.
16. Do not connect via an extension lead or Multi-socket plug. Extension leads and Multi-socket plugs do not guarantee the required safety of the appliance (e.g. danger of overheating).
17. Do not use the appliance without the air filter. Check and if necessary clean the air filter every two weeks.
18. Do not leave the appliance unattended over a long period of time. Leaving your appliance unattended for long periods of time with an uncleaned filter may lead to a fire hazard.
19. Do not use the Laundry Mode function over a long period of time.
20. At the end of its working life dispose of the appliance responsibly, in accordance with local regulations.
21. Before cleaning or maintaining the appliance, please turn off the power and unplug.
22. Do not insert or pull out the power plug with wet hands.
23. Do not operate heating equipment around the appliance.
24. Keep a safe distance from fire source, inflammable and explosive objects.
25. Keep children from playing with or climbing on the appliance.
26. Never open the unit casing yourself and attempt to repair. This will void the warranty and is a potential health and safety risk.
27. This appliance is not for use in a Server Room or any other similar environment.
28. Dispose of the water collected from the dehumidifier, this water is not drinkable.
29. Do not remove the water tank when running, this may cause water to leak.
30. When using the "LAUNDRY" mode to dry wet clothes efficiently, keep the laundry at a safe distance from the dehumidifier to prevent water from dripping onto the dehumidifier.

This appliance is not intended for use by persons (including children) with reduced physical, sensory or mental capabilities, unless they have been given supervision or instruction concerning use of the appliance by a person responsible for their safety. Children should be supervised to ensure that they do not play with the appliance.

READ & SAVE THESE IMPORTANT SAFETY INSTRUCTIONS FOR FUTURE REFERENCE

KEY FEATURES

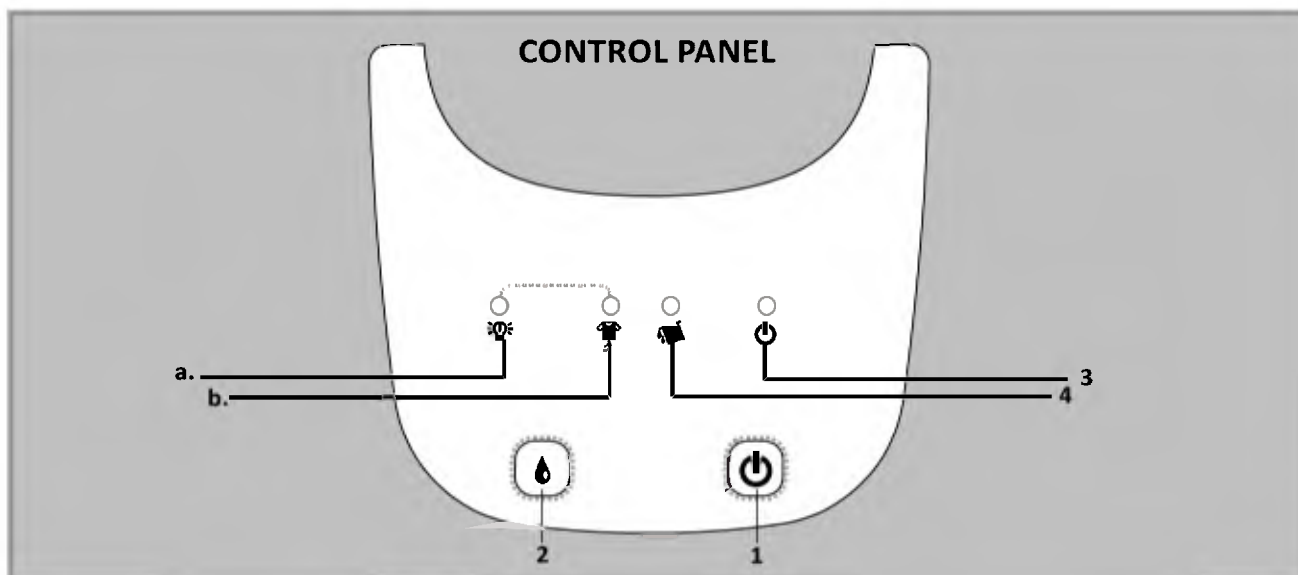

1. **Power Key** - Turn unit on **ON/OFF**.
2. **Dry Mode Key** - Select:
 - a. **Smart Mode** - Press once. The dehumidifier will operate until it reaches a relative humidity between 45%RH - 55%RH
 - b. **CONTINUOUS LAUNDRY MODE** - Press twice. The dehumidifier will run continuously. It will rest every 36 hours for 15 minutes to preserve the compressor and save energy.
3. **Power On Indicator Light** - The light will turn on when dehumidifier is on and off when on standby mode.
4. **Water Full Light Indicator** - Lights up when Water Tank is full, missing or is inserted incorrectly.

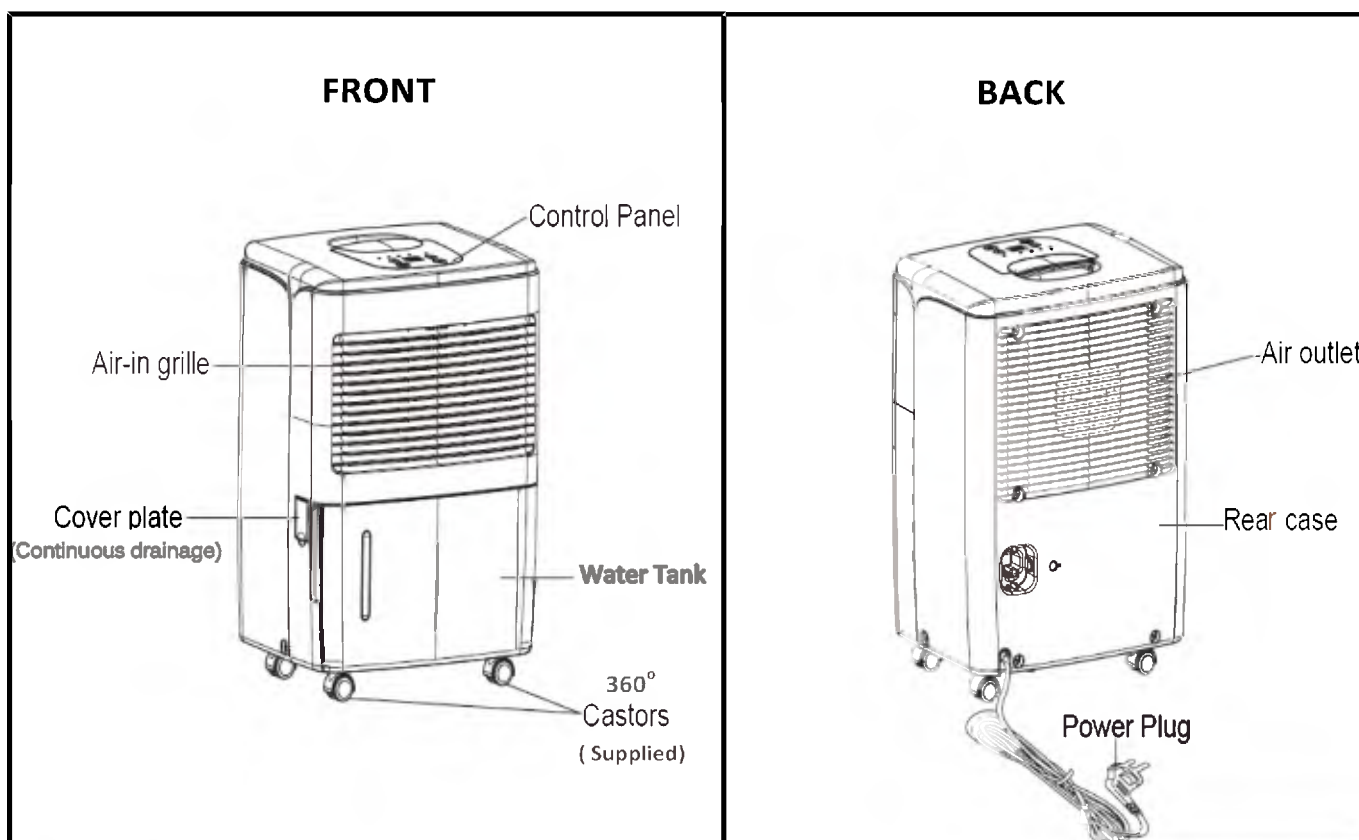

QUICK START UP

CASTOR WHEEL INSTALLATION

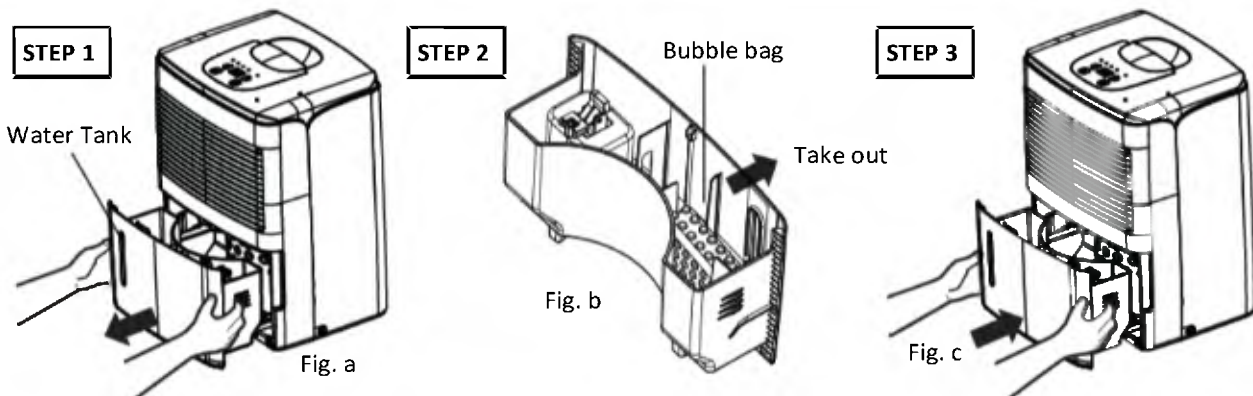

1. Hold the grip on the both sides of the water tank and gently remove the water tank. (As shown in fig.a)
2. Remove bubble bag from inside the water tank. (there are 4 castors and 1 cable tie as shown in fig.b)
3. Insert the water tank to its original position. (As shown in fig.c)
4. Remove 4 castors and 1 cable tie from bubble bag.

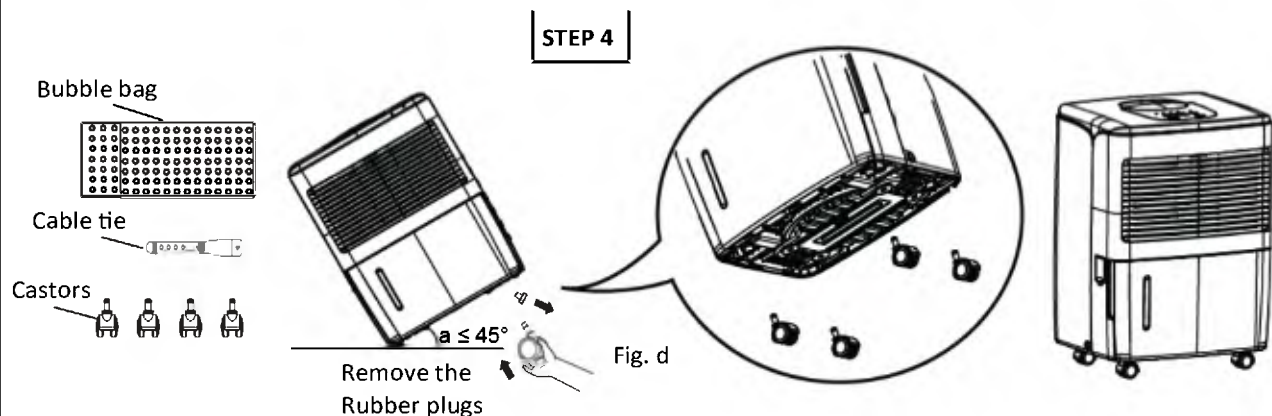

5. Tilt the dehumidifier at no more than 45° . Remove the four rubber feet from underneath of the unit. Aim the shaft of castor at the installation hole on chassis, and then push the castor into it. Repeat the same for the 3 other castors, then leave the unit on the up right position on the floor. (As shown in fig.d)

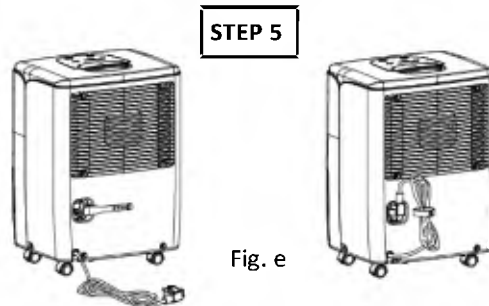

6. To tidy the power cable at the rear, use the cable tie provided with the dehumidifier. Put the power plug into the clamp. (As shown in fig.e)

NOTE:

1. It is advisable that during castors installation the dehumidifier should be held by another person
2. Four castors must be installed correctly before operating the unit.
3. Remove the plastic bag from bucket (even if the castor wheels are not needed).

QUICK START UP

BEFORE STARTING TO USE THE DEHUMIDIFIER

Note:

- Please first check the float is properly placed
- Water tank must be correctly installed for the dehumidifier to operate
- Do not remove the water tank while dehumidifier is in operation.

1. Hold the grip on both sides of the water tank and gently remove.

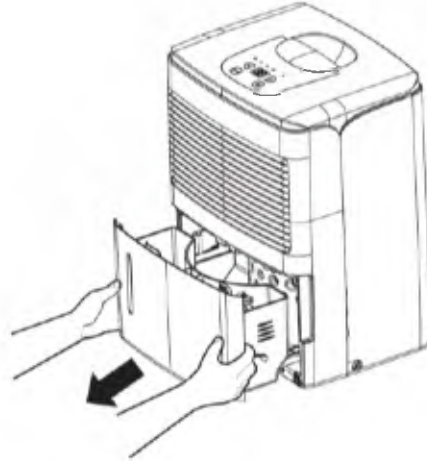

2. Check the float to ensure it is correctly aligned:

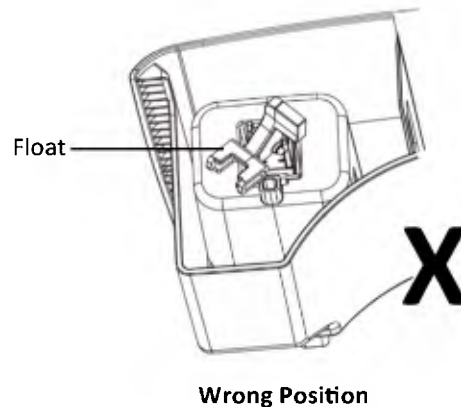
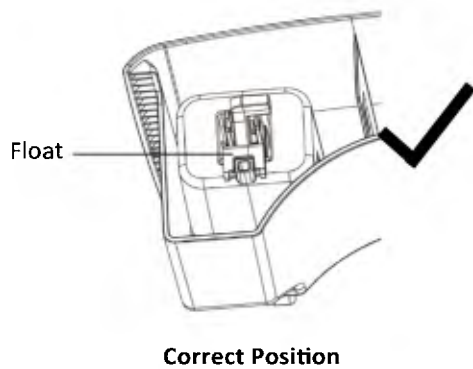

3. Insert the water tank back to position:

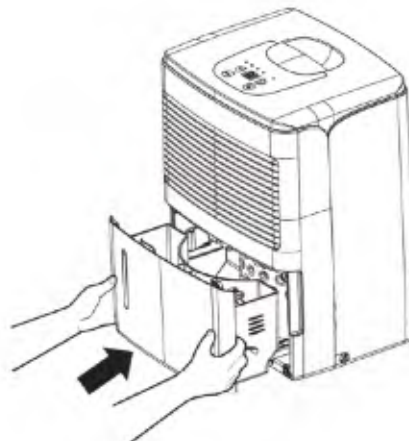

Empty Water Tank Instructions

STEP 1 - WHERE TO POSITION YOUR DEHUMIDIFIER?

After unpacking your dehumidifier, place it upright to allow the compressor to stabilise for at least 4 hours before use.

Ensure the dehumidifier is a safe distance away from a wall or furniture, away from direct sunlight.

TIP: Position the dehumidifier in the dampest room or somewhere central like a landing or a hallway. As long as the internal doors are open the excess moisture from all of the rooms in the house will migrate naturally towards the dehumidifier and be processed.

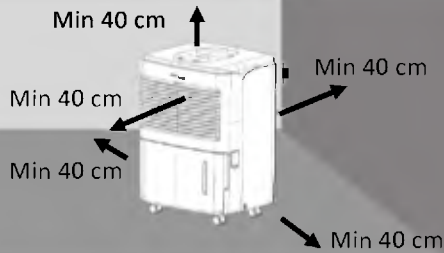

STEP 3 - ON/OFF

TO OPERATE UNIT

- Place the unit in an upright position on an even level surface.
- Plug the unit into the mains socket.
- The dehumidifier performs best at a minimum ambient temperature of 15°C . Where ambient temperature is below 15°C it may go into defrost mode periodically to preserve the life of the compressor.
- Press the ON/OFF button to operate the dehumidifier.
- Now select Mode. (See step 4)

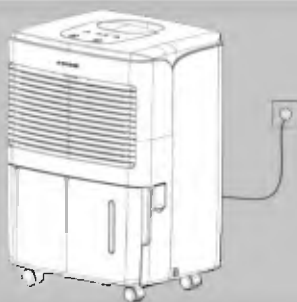

USEFUL INFORMATION

Memory Function - If power is lost, all of the control settings are remembered. So when power is restored, the unit will start back up in the settings it was in when power was lost.

STEP 2 - CAUTION - AVOID USING IN



- Areas where temperature falls below 5°C or above 32°C.
- Small confined area i.e. broom cupboard, boiler room, unventilated rooms etc.
- Close proximity to a heat source such as heater, tumble dryer, cooker.
- Do not attempt to roll the dehumidifier on carpet or over objects. Otherwise, water may spill out from the water tank or damage the unit.
- Dusty or building sites or an industrial environment where particles can clog up the filter or internal components. This will cause the unit to malfunction, voiding your guarantee.



STEP 4 - DRY MODE



Smart

Select to keep the room at a comfortable level

- Select the smart mode to keep the room at a comfortable level between 45% - 55%RH. On this mode the unit will stop when the humidity reached its level and the unit will switch back on again when humidity level go up higher than this level.



Continuous Laundry Mode

Select to run in Continuous Laundry mode

- The dehumidifier will operate continuously at its maximum dehumidification settings until setting is changed or the water tank is full.

Note: If connected to a hose pipe for continuous drainage the dehumidifier will continue operating on this settings with regular intervals of rests.

STEP 5 - TANK FULL INDICATOR

- Indicator lights up when water tank is full or incorrectly inserted. The dehumidifier will automatically switch off.
- Remove water tank, empty and put it back correctly.

Note:

If the tank is full or removed for more than a 3 minute period:

- an alarm will sound for about 10 seconds to alert the water tank needs emptying or placing back into position.
- The controls are disabled.

Continuous Drainage Instructions

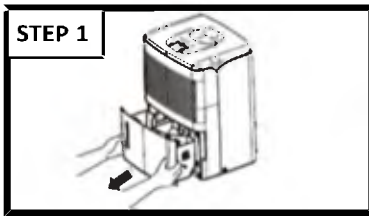

Pull water tank out

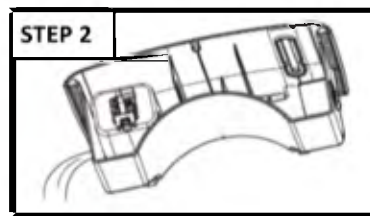

Pour the water away

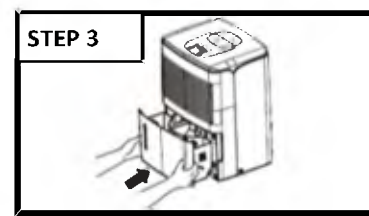

Insert the water tank

1. The Water Full Indicator lights up when the water tank is full and the unit stops operating.
2. Do not move the dehumidifier or remove the water tank when the dehumidifier is running, as water may leak; causing damages to the dehumidifier or an electric shock.
3. Before removing the water tank leave the dehumidifier to stand for approximately 10 minutes to ensure all water has dripped into the water tank.
4. Hold the grip on both sides of the water tank and pull it out following the arrow direction. (Attention: Gently pull out the tank to avoid water spill out onto the floor.) (See Step 1 picture)
5. To empty the tank, hold the grip with one hand and hold the base of the tank with other hand, pour the water away as step 2 picture. Then, clean the water tank, if needed.
6. Put the water tank back into the unit (See step 3 picture). Do not leave the unit without the water tank for not more than 5 minutes to avoid water leaking onto the floor.

NOTE :

- Clean the water tank with clean water if needed. Do not use detergent, solvent, abrasive or hot water to avoid damaging the water tank or float.
- Do not remove or damage the float in the water tank or the dehumidifier will not operate properly.
- The water full light indicator illuminates if the water tank is not correctly in position.
- Do not tilt the dehumidifier when removing the water tank.
- If the water tank is removed whilst the dehumidifier is running the fan will continue to run for 3 minutes and it will stop.
- Do not tilt the dehumidifier when removing the water tank.
- If the water tank is removed whilst the dehumidifier is running the fan will continue to run for 3 minutes.

CONTINUOUS DRAINAGE

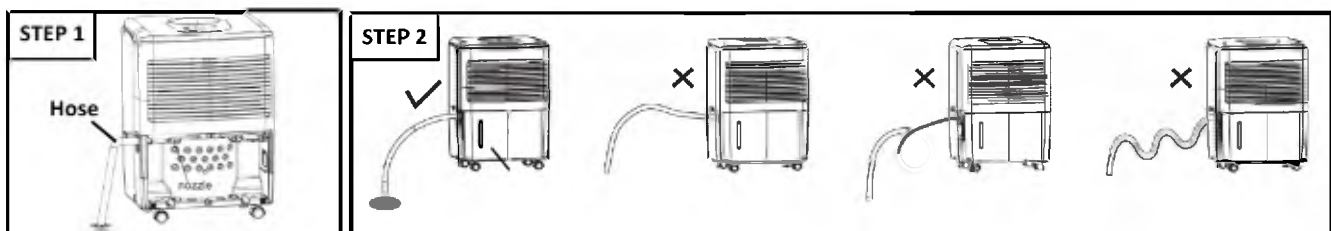

You may use a hose with an inner diameter of 14mm for continuous drainage (supplied):

1. Remove tank from the dehumidifier as instructed (Picture on Step 1). Lift up nozzle flap on the side of the dehumidifier, thread the drain hose into the nozzle and ensure it's securely inserted.

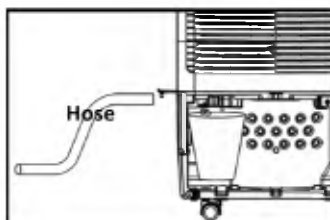

2. Replace the water tank. Make sure the drain hose goes through the drain hole on the sidepanel and is placed downward. The hose must lead to an appropriate drain at a downward slope with no sharp bends or the drain hose should not be kinked, otherwise water can not be drained out (Picture on Step 2)

NOTE: When removing the drain hose, use a cup to collect any dripping water from the nozzle.

MAINTENANCE

STEP 1 - CLEANING YOUR FILTER

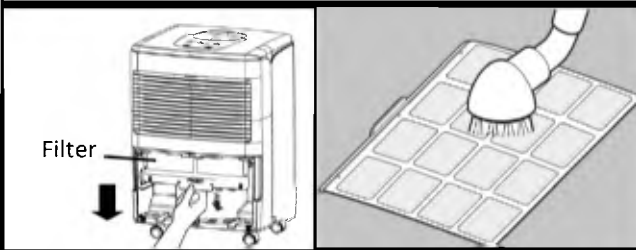

1. Turn OFF the dehumidifier and remove the filter from the unit. Hold the filter grip, pull it straight down and out.
2. Clean the filter use the vacuum cleaner or wash in warm, soap water, rinse it and let it air dry fully.
3. Replace the filter back into the right position.
4. If the filter is covered with dust, the airflow and the performance of the dehumidifier will be affected. Check the filter periodically to ensure all dust is removed.

Tip: Clean your filter once every 2 weeks to keep your air clean and prolong the life of your dehumidifier. The frequency will depend on conditions of operation.

STEP 2 - REPLACING YOUR FILTER

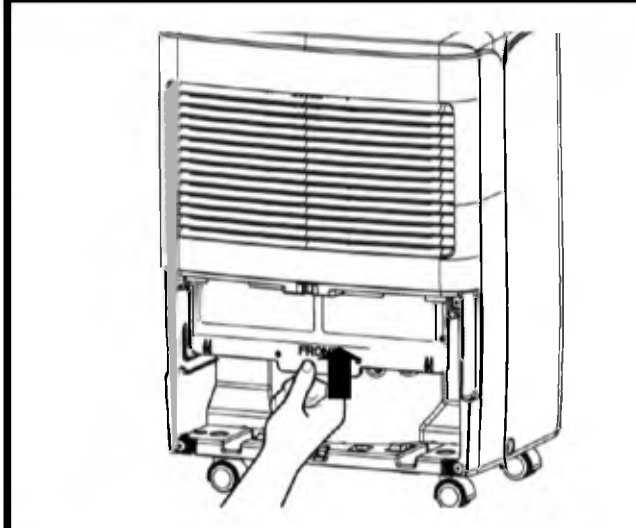

It is recommended that the filter is replaced every year for optimal performance and hygiene standards. The frequency depends on the duration and conditions of operation. To purchase a replacement filter please visit:

www.ecoairdirect.com

STEP 3- CLEANING YOUR DEHUMIDIFIER

1. Turn the dehumidifier OFF, wait for the fan to stop and unplug the unit from the socket.

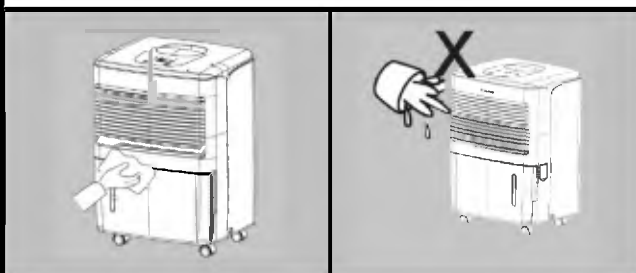

3. Clean the surface with a soft damp cloth.
3. Dry thoroughly with a dry towel after cleaning.
4. Empty the water tank. Allow water tank to dry or dry with a cloth.
5. Please take care when cleaning or drying

Caution:



- Do not wash the unit or immerse in water.
- Do not let water drip into the air inlet or outlet.

STEP 4 - STORING YOUR DEHUMIDIFIER

1. Turn OFF the dehumidifier, wait for the fan to stop and unplug the dehumidifier from the power socket.
2. Leave the dehumidifier to drain for approximately one day. Clean and dry the water tank.
3. Clean the filter and the dehumidifier. Cover the dehumidifier to prevent it from gathering dust. Store upright in a cool dry place.
4. Do not expose to direct sunlight.

TROUBLESHOOTING

THE FOLLOWING POINTS BEFORE CONTACTING TECHNICAL SUPPORT.

PROBLEM	REASON	SOLUTION
 No Power	Dehumidifier is not plugged in or there is no power supply	Plug the dehumidifier into mains and switch plug ON. Check the main power supply
	Dehumidifier has reached its pre-set level or tank is full.	The dehumidifier automatically turns off when smart mode condition occurs or the tank is full. Empty the tank and replace properly or select continuous (laundry) mode .
	Water tank is not in the proper position.	The water tank must be in place and securely seated for the dehumidifier to operate.
	Power failure/Controls cannot be set	There is a protective time delay to protect the compressor. For this reason, the dehumidifier may not start normal dehumidifying for 3 minutes after it is turned back on.
 Water Full Light On	Water tank is full or installed incorrectly	Empty water tank or re-install correctly
	Water float out of position	Restore water float back into position
	Dehumidifier on uneven surface or water tank fitted incorrectly	Ensure the dehumidifier is on a flat, even surface, use a spirit level to check, remove tank and replace correctly
Water Leaking	Damaged water tank	Remove the water tank, fill with water and place on a hard even surface to test for leaking.
	The continuous drainage is clogged or loose Dehumidifier operating in colder environment Do not use in dusty environment and Clean the air filter regularly.	Check the continuous drainage hose and its connection Ensure room is within operating temperatures. Do not use in dusty environment or the filter not maintain correctly.
Not Collecting Water	Did not allow enough time to remove moisture	When first installed, allowed at least 24 hours to maintain the desired dehumidification
	Set Smart mode reached	Reset to continuous (laundry) mode
	Room is very cold or very dry for the current settings	Check room temperature and humidity levels eg. Humidity low or room cold Check room temperature and Increase the room temperature or set on continuous mode
	Filter dusty	Clean the air filter or replace it
	Room Temperature is too hot	Open the window or door to ventilate
	Room Temperature is too cold or humidity is low	Increase heat in the room Not much moisture in the room
Noisy	Water tank or filter fitted incorrectly Dehumidifier on uneven surface	Check and refit the water tank or filter Check dehumidifier is on an even level surface
	There is sound created when wind passing the dehumidifier.	This is normal
	Dehumidifier is placed on uneven floor	Place your dehumidifier on even floor
Frost Appears on Coils	Dehumidifier has been recently turned on, or room temperature is below 5°C	This is normal. Frost will usually disappear within 60 minutes. Do not operate the dehumidifier in temperatures below 5°C
Dehumidifier Run Too Much	Area to be dehumidified is too large	The capacity of your dehumidifier may not be adequate.
No Response on Control	Dehumidifier work out of temperature range	The dehumidifier is working out of the temperature range which higher than 32°C or below 5°C

In the unlikely event of a problem with your product, please refer in the first instance to:
ECOAIR TECHNICAL SUPPORT
www.ecoair.org/support

SPECIFICATIONS

MODEL	VEBO	
Temperature Range	5°C ~ 32°C	
Dehumidification Extraction Rate	30°C, 80%RH	10 Litres / day
	Max	12 litres / day
Water Tank Capacity	1.5 Litres	
Voltage	220 - 240V~50Hz	
Net Weight	11.5 Kg	
Gross Weight	12.5 Kg	
Net Dimension (W x H x D)	310mm x 400mm x 243mm	
Gross Dimension (W x H x D)	345mm x 425mm x 298mm	

GUARANTEE CARD

EcoAir guarantees this product to be free from defects in materials and workmanship for a period of (2) years from the date of purchase. Coverage is valid only with proof of purchase.

Warranty Terms and Conditions

The conditions below apply to our warranty. They do not affect your statutory rights or the obligations of your retailer and your contract with them.

We provide warranty cover for this appliance subject to the following conditions:

1. We will rectify defects affecting the appliance which are clearly attributable to material and/or manufacturing faults, provided they are reported immediately after being identified within the Warranty Period supported by proof of purchase.
2. Service may not be available to all the islands around the UK. Please check with your retailer or contact our customer service department.
3. The warranty will not extend to consumables such as air filters.
4. Warranty liability will not be triggered by minor variances from nominal features which are of no significance to the appliance's value or fitness for purpose, nor damage caused by wear and tear, exceptional environmental conditions and inappropriate operating conditions.
5. No warranty liability will be accepted:-
 - a. If the defects stem from transport damage for which we are not responsible.
 - b. Improper installation and assembly or non-compliance with the safety regulations and warnings given in the operating instructions.
 - c. Improper use, to also include poor maintenance caused by insufficient aftercare or cleaning and failure to observe operating or assembly instructions or use with improper voltage recommendations.
 - d. Use in a non-domestic environment, to include appliance for rental.
6. No rights are given under this warranty to a person acquiring the appliance second hand.
7. We reserve the right to invalidate the warranty:-
 - a. If repairs or other interventions are performed by persons not authorised by us.
 - b. If our appliances are fitted with non-original spare parts, extras or accessories.
 - c. If our appliance has been altered and damaged by owner or third parties.
 - d. In the event of abuse (whether physical or verbal abuse) towards any member of staff.
8. Warranty provision will be free of charge and we will decide whether this will take the form of a repair or the replacement of the appliance. Small appliances that can be reasonably transported or posted may need to be handed over or shipped to our customer service centre. A purchase receipt must be presented in each case. Replaced parts pass into our ownership.
9. Under no circumstances shall the application of this warranty give rise to the complete replacement of the appliances. In the event of a replacement appliance being supplied at our discretion, we reserve the right to charge an appropriate monetary offset in respect of the period of use already enjoyed.
10. The provision of services under warranty neither extends the term of the warranty nor sets in motion a new Warranty Period. The Warranty Period for spare parts fitted ends with the expiry of the warranty on the appliance as a whole.
11. EcoAir shall not be liable for loss of goods, loss of use, or any special, indirect, consequential or pure economic loss, costs, damages, charges or expenses.
12. Our Warranty service is on a return to base basis.
13. This unit is only for domestic use.
14. The Customer acknowledges and agrees that details of the Customer's name, address and payment method will be held and used by EcoAir to provide the services and to send to the Customer further information. EcoAir may disclose your information to third parties and agents in order to perform the services.

These warranty conditions apply to appliances purchased in the United Kingdom. If appliances shipped to other countries feature the appropriate technical conditions (e.g. voltage, frequency, gas-types etc.) for the climatic and environmental conditions in the country concerned, the terms of the warranty will apply, provided a local customer service network exists. Appliances purchased outside the United Kingdom are subject to the warranty conditions published by the appropriate local representative office of that country. These can be obtained via the specialist dealer from whom you bought appliance.

ecoair®

www.ecoair.org
C387 — 18092018





66129930266