



---

**DD128**

---

## Desiccant Dehumidifier



## Congratulations!

You have purchased the very latest in dehumidification technology. Your new EcoAir high efficiency room appliance will give you many years of dependable service. Many features have been built into your EcoAir portable appliance to assure quiet operation, functional controls and the most economical operation.

<b>BS Plug wiring .....</b>	<b>Page 3</b>
<b>Introduction .....</b>	<b>Page 4</b>
<b>Important Safety Instructions .....</b>	<b>Page 5</b>
<b>Key Features .....</b>	<b>Page 6</b>
<b>Quick Start Up .....</b>	<b>Pages 7 - 8</b>
<b>Empty Water Tank Instructions.....</b>	<b>Page 9</b>
<b>Continuous Drainage Instructions .....</b>	<b>Page 9</b>
<b>Maintenance .....</b>	<b>Page 10</b>
<b>Troubleshooting .....</b>	<b>Page 11</b>
<b>Specifications .....</b>	<b>Page 11</b>
<b>Guarantee Card .....</b>	<b>Page 12</b>

**When using this appliance in European countries, the following information must be observed:**

Do not dispose of this product as unsorted waste.

It is prohibited to dispose of this appliance as domestic household waste. For disposal:

- a. Contact your local council
- b. The manufacturer will take back the old appliance for disposal when you replace it with a new product.
- c. Old products contain valuable resources, which should be recycled as scrap metal.





WEE/EC2601UR

Wild disposal of waste in forests and landscapes endangers your health when hazardous substances leak into the ground-water and find their way into the food chain.

**Wiring Instructions:** Should it be necessary to change the plug, please note the wires in the mains lead are coloured in accordance with the following codes:



**BLUE - NEUTRAL**  
**BROWN – LIVE**  
**GREEN AND YELLOW - EARTH**

In the event that the colours of the wires in the mains lead of this appliance do not correspond with the coloured markings identifying the terminals in your plug, proceed as follows:

1. The **BLUE** wire is **NEUTRAL** and must be connected to the terminal which is marked with the letter **N** or coloured **BLACK**.
2. The **BROWN** wire is **LIVE** and must be connected to the terminal which is marked with the letter **L** or coloured **RED**.
3. The **GREEN/YELLOW** is **EARTH** and must be connected to the terminal which is marked with the letter **E**  or  or coloured **GREEN** or **GREEN/YELLOW**.
4. Always ensure that the cord grip is positioned and fastened correctly.

If a **13A (BS 1363)** fused plug is used it must be fitted with a **13A** -fuse. If in doubt consult a qualified electrician.

### Wiring for a 13 Amp Plug (BS1363)

Please note. The Earth Terminal is marked with the letter **E**  or  Earth Symbol.

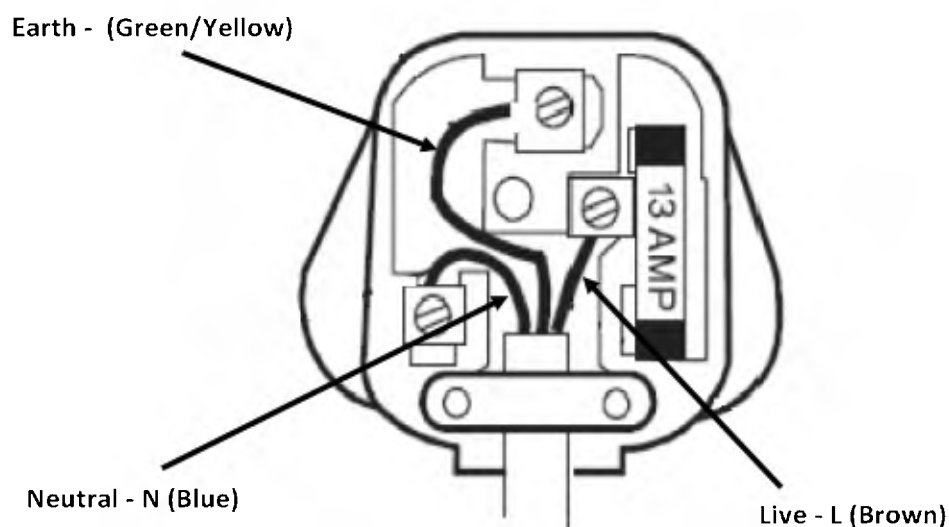

Thank you and congratulations for choosing an EcoAir dehumidifier to help you control the Relative Humidity within your home. Inside this manual you will find many helpful tips on how to use and maintain your dehumidifier efficiently. Just a little preventative care can save you money and prolong the life of your dehumidifier.

The purpose of the dehumidifier is to remove the excess moisture in the air by detecting the humidity level in the room. By keeping humidity within recommended levels, a dehumidifier combats household damp, mould and mildew. Dehumidifiers can help to reduce the symptoms of asthma, allergies, and other respiratory health conditions. They can also be used to help dry laundry quicker and control moisture-based damage (such as the aftermath of flooding, leaks or rising damp) to valuable belongings and furniture.

## HUMIDITY GUIDE

There will always be water vapour in the air. The water vapour (or commonly known as moisture) in the air is measured in % Relative Humidity (RH). RH is the ratio of the actual amount of water vapour in the air to the amount it could hold when saturated expressed as a percentage. Too much or too little moisture in our homes can be unhealthy and uncomfortable. The optimum humidity level is between 40% and 60% (RH) where we feel most comfortable.

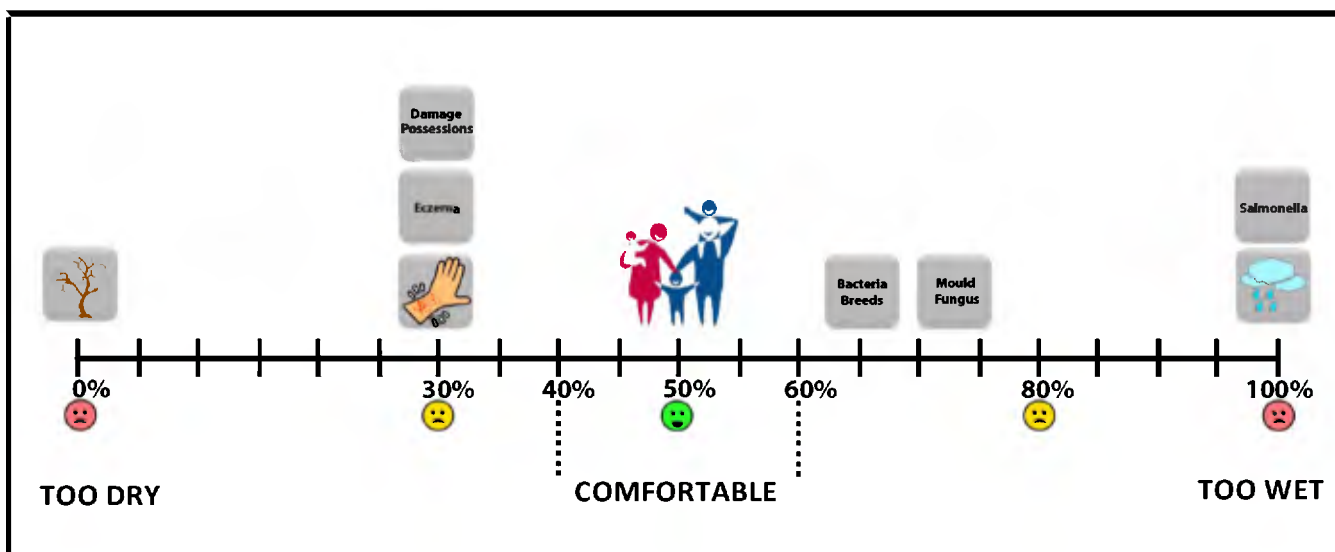

## LOW HUMIDITY

Low humidity indoors causes excess drying which can trigger skin irritations such as eczema, chapped skin and dry nose. It can also damage possessions, such as wooden furniture, musical instruments and artwork by drying it out too much.

## HIGH HUMIDITY

High humidity indoors causes damp and condensation. The damp left by condensation can damage plaster, wall paper, furniture, vehicles, timber windows, doors and clothes. It can be harmful to our health when bacteria thrives, causing mould and fungus.

## MAINTAINING SAFE LEVELS OF HUMIDITY

It is important to maintain a consistent humidity range to preserve furniture, paintings, door and window frames. High humidity causes swelling, corrosion, softening of glues and paint. Low humidity causes shrinking, cracking, warping of wood surfaces and gaps in joints, doors and windows. Frequent changes in humidity levels can accelerate damages to property and belongings.

## CONDENSATION

The warmer the air, the more moisture the air can hold than colder air. So, when the air inside the house becomes colder, the moisture contents in the air becomes saturated, and gets heavier resulting in moisture concentration on the coldest parts of the house particularly on the windows, bathroom mirrors and walls. This is condensation, caused by a sudden increase in humidity, cooking, showers, drying clothes, inadequate ventilation and poor thermal insulation.

Condensation does not disappear instantly even with the dehumidifier on. Where excessive condensation appears for example, on your windows, you may want to open your windows to expel the excess humidity for several minutes. It will take a while for the condensation to generally increase the humidity in the room. Once the humidity level in the room around the dehumidifier is increased above the level you have set on the dehumidifier, it will then begin the dehumidification process.

# IMPORTANT SAFETY INSTRUCTIONS

PLEASE READ ALL INSTRUCTIONS CAREFULLY BEFORE OPERATING.

## WARNING!

This appliance is intended for domestic use only. It is not suitable for outdoor use. Any other use is not recommended by the manufacturer and may cause fire, electrical shocks or other injuries to person or property. EcoAir cannot be held liable for damage resulting from incorrect or improper use or operation.

### When using electrical appliances, basic safety precautions should always be followed:

1. Do not operate the appliance if there is a damaged cord, plug or after it malfunctions if it has been dropped or damaged in any way. Arrange for the appliance to be examined or repaired by an authorised technician.
2. Always keep the appliance in an upright position to avoid any damage. Place the appliance on an even level surface during operation.
3. Ensure the household voltage matches the rated specification for the appliance before use.
4. Operate this appliance in an ambient temperature between 1°C and 40°C.
5. Ensure that the air inlets and outlets are not blocked or covered. Do not insert fingers or any objects into the air inlet or outlet openings.
6. Do not place the unit too close to curtains or any other objects, keep minimum distance of 40cm.
7. Never place anything on top of the appliance and do not cover while in use.
8. To protect against electric shocks, do not immerse or spray the appliance or any of its parts in water.
9. Never unplug the power cord without switching OFF the appliance first.
10. Always unplug the appliance when not in use or when moving location. To disconnect the appliance from the power supply, grip the plug and pull from the power socket. Never pull by the cord.
11. Always empty the internal water tank before storing the appliance away.
12. Close supervision is necessary when the appliance is used in the presence of children and pets.
13. Do not run power cord under carpeting, or cover with rugs or runners. Arrange the cord away from areas where it may become a trip hazard.
14. Never operate or store the appliance in direct sunlight.
15. Repairs must be carried out by an authorised technician, failure to do so may cause damage to the appliance or injury to persons or property and will void the warranty. Always insist on original spare parts.
16. Do not connect via an extension lead or Multi-socket plug. Extension leads and Multi-socket plugs do not guarantee the required safety of the appliance (e.g. danger of overheating).
17. Do not use the appliance without the air filter. Check and if necessary clean the air filter every two weeks.
18. Do not leave the appliance unattended over a long period of time. Leaving your appliance unattended for long periods of time with an uncleaned filter may lead to a fire hazard.
19. Do not use the Laundry Mode function over a long period of time.
20. At the end of its working life dispose of the appliance responsibly, in accordance with local regulations.
21. Before cleaning or maintaining the appliance, please turn off the power and unplug.
22. Do not insert or pull out the power plug with wet hands.
23. Do not operate heating equipment around the appliance.
24. Keep a safe distance from fire source, inflammable and explosive objects.
25. Keep children from playing with or climbing on the appliance.
26. Never open the unit casing yourself and attempt to repair. This will void the warranty and is a potential health and safety risk.
27. This appliance is not for use in a Server Room or any other similar environment.
28. Dispose of the water collected from the dehumidifier, this water is not drinkable.
29. Do not remove the water tank when running, this may cause water to leak.
30. When using the "LAUNDRY" mode to dry wet clothes efficiently, keep the laundry at a safe distance from the dehumidifier to prevent water from dripping onto the dehumidifier.

This appliance is not intended for use by persons (including children) with reduced physical, sensory or mental capabilities, unless they have been given supervision or instruction concerning use of the appliance by a person responsible for their safety. Children should be supervised to ensure that they do not play with the appliance.

**READ & SAVE THESE IMPORTANT SAFETY INSTRUCTIONS FOR FUTURE REFERENCE**

## CONTROL PANEL

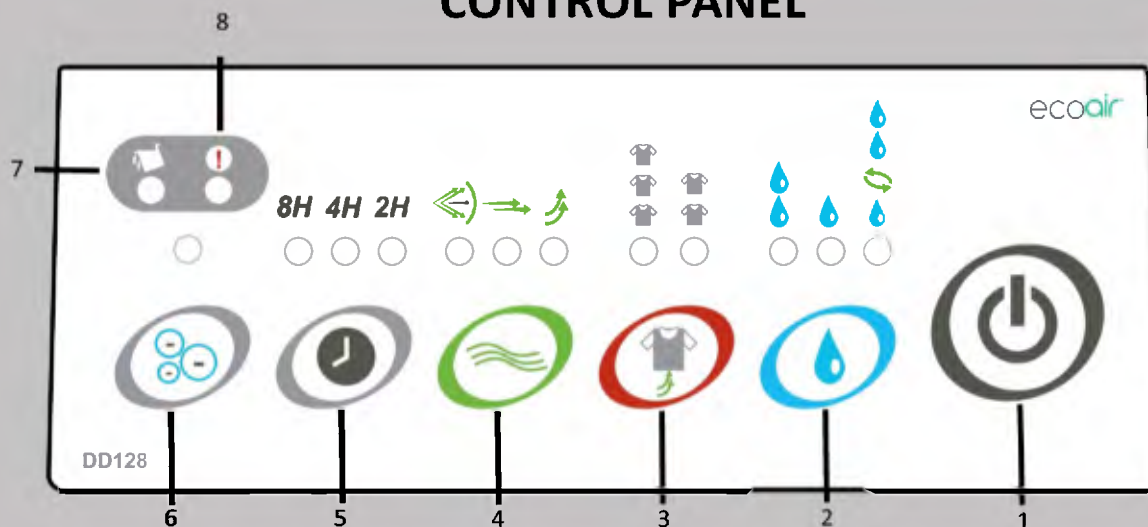

- 1. Power Key** - Turn unit on **ON/** **OFF.**
- 2. Dry Mode** - Select **AUTO** or **ECONOMY** or **HI** settings.
- 3. Laundry Mode** - Select **NORMAL** or **TURBO** modes.
- 4. Louvre Setting Control Key** - Select **UP** **FRONT** **WIDE** or **HOLD**.
- 5. Timer Key** - Select **2** or **4** or **8** hours' timer on.
- 6. Ioniser Key** - Select **IONISER** for cleaner air.
- 7. Water Full Indicator** - Indicator lights up when the water tank is full or incorrectly installed.
- 8. Check Indicator** - Indicator lights up when the unit needs attention.

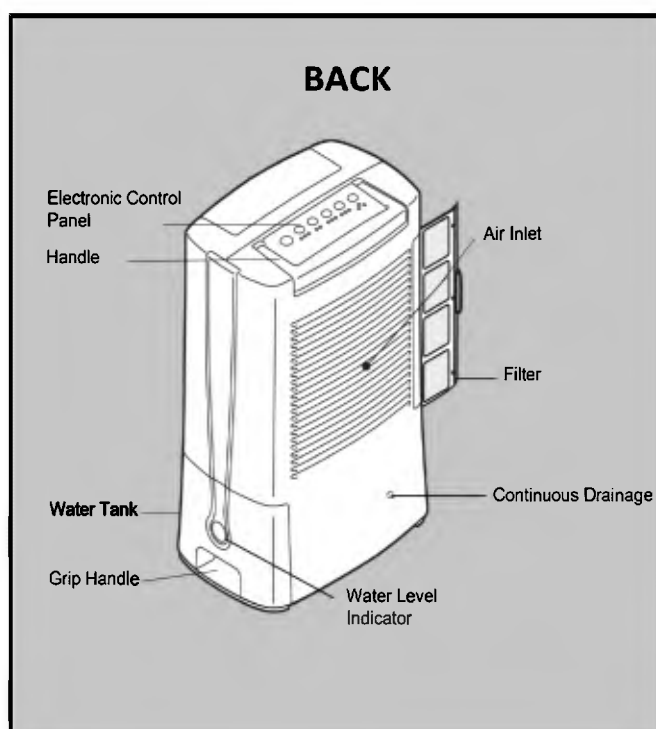
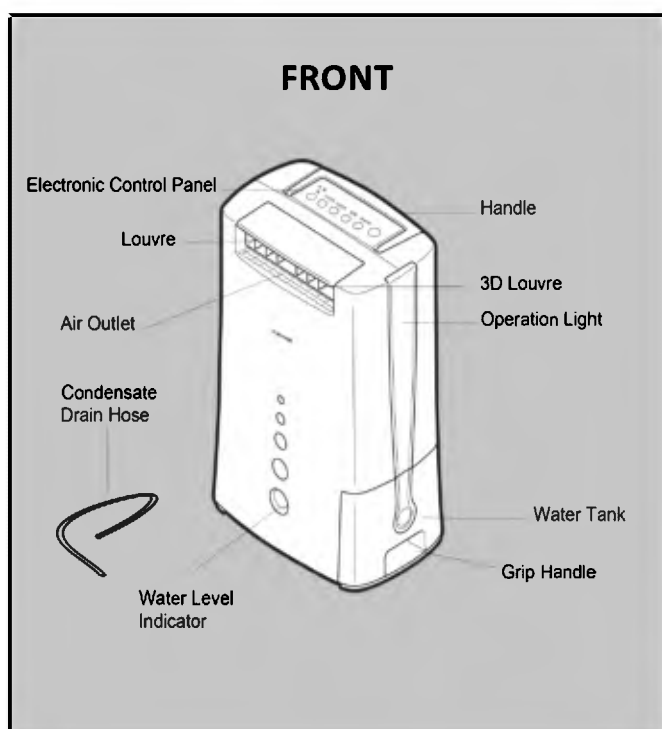

# QUICK START UP

## STEP 1 - WHERE TO POSITION YOUR DEHUMIDIFIER?

Ensure the unit is a safe distance away from a wall or furniture, away from direct sunlight.

**TIP:** Position the dehumidifier in the dampest room or somewhere central like a landing or a hallway. As long as the internal doors are open the excess moisture from all of the rooms in the house will migrate naturally towards the dehumidifier and be processed.

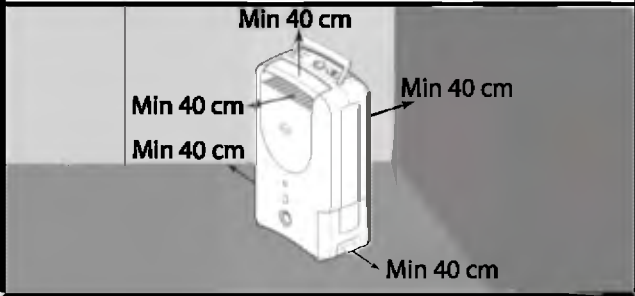

## STEP 2 - CAUTION - AVOID USING IN

- Small confined area i.e. broom cupboard, boiler room, unventilated rooms etc.
- Close proximity to a heat source such as heater, tumble dryer, cooker.
- Dusty or building sites or an industrial environment where particles can clog up the filter or internal components. This will cause the unit to malfunction, voiding your guarantee.

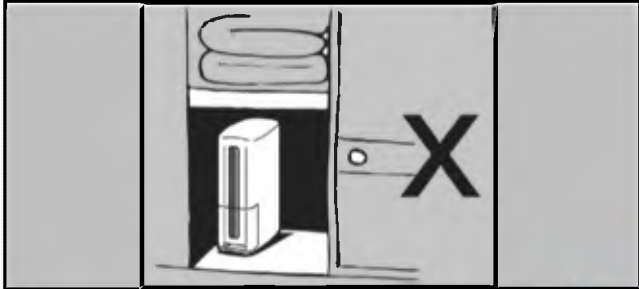

## STEP 3 - ON/OFF

- TO OPERATE UNIT**
- Place the unit in an upright position on an even level surface.
  - Plug the unit into the mains socket.
  - Press the ON/OFF button to operate the unit.
  - Now select Mode. (See step 4)

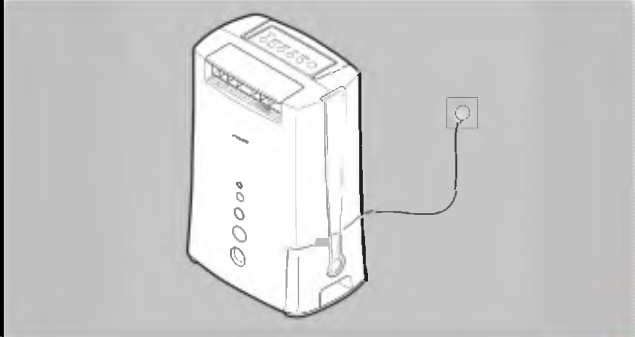

## STEP 4 - DRY MODE

- Auto**
- Select to keep the room at a comfortable level
  - Toggles automatically to control humidity to approximately 50-60% RH. Optimises energy saving and comfortable humidity level.
- Economy**
- Select to run in Economy mode
  - The unit dehumidifies in Economy mode and in a quiet setting to approximately 50-60% RH.
  - Use this mode in your daily normal household once the ideal humidity level has been reached. Highly recommended for night use.
- Hi**
- Select High mode to quickly control high levels of humidity
  - The unit brings the humidity down to approximately 40-45% RH to control problem areas quickly.
  - **Important:** Once you reach desired RH, switch from HIGH to ECONOMY for energy savings.

## STEP 5 - LAUNDRY MODE

Use for drying clothes. The appliance will continuously dry the air until you switch to one of the Dry Modes. It typically takes 2 – 4 hours to dry your laundry.

- Normal**
- Use Normal Laundry mode to dry your laundry at low energy saver operation. Tip: Use during summer time.
- Turbo**
- Use Turbo Laundry mode to dry your clothes over a shorter period of time or dry a very damp room quickly. Tip: Use during winter time.

**TIP:** Avoid using the Laundry modes for normal daily use. You may use to dry very damp rooms over 2 – 3 days and then switch to the recommended Economy mode.

## STEP 6 - SWING MODE

Select swing for Wide, Front or Up as desired. To hold the swing, press Swing until LED is off.

- Up**
- The automatic louvre swings in an upward range of approximately 100°
- Front**
- The automatic louvre swings in a front range of approximately 50°
- Wide**
- The automatic louvre swings in a wide range of approximately 150°
- Hold**
- To hold the swing, press Swing until LED is off.
-

# QUICK START UP

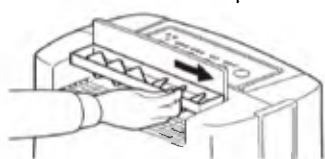
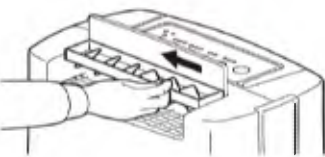
STEP 6 CONTINUED - 3D LOUVRE	
Wide Air-flow	<ul style="list-style-type: none"> <li>Rotate to the WIDE position</li> </ul> 
Spot Air-flow	<ul style="list-style-type: none"> <li>Rotate to the SPOT position</li> </ul> 
<p><b>Note:</b> To avoid damage, do not touch the louvre whilst in swing mode.</p>	

STEP 8 - IONISER
<ul style="list-style-type: none"> <li>Press the "IONISER" Key to turn the ioniser ON or OFF.</li> </ul>
<ul style="list-style-type: none"> <li>When the LED is on, the unit releases negative ions from the air outlet to purify the air.</li> </ul>
<ul style="list-style-type: none"> <li>Negative ions have a normalizing effect on our bodies. Providing the ideal conditions for the body, aiding breathing and relaxation.</li> </ul>
<p><b>TIP:</b> Whilst the dehumidifier is running, turning on the ioniser effectively purifies the air with negative ions and silver ion filtration.</p>

USEFUL INFORMATION
<ul style="list-style-type: none"> <li>After turning the dehumidifier OFF, the fan will continue to run for a two minute period. This is a normal procedure and helps to cool &amp; protect the internal components. During these two minutes <b>DO NOT</b> remove the power plug from the power socket; wait for the fan to stop running.</li> </ul>
<ul style="list-style-type: none"> <li>When you first use your dehumidifier it will work harder to reduce the room humidity to it's target of i.e. approximately 50-60%RH (on Auto mode), this is the time when it will produce the most water and need emptying most frequently. As the room becomes drier the dehumidifier collects less water and runs at a lower fan speed.</li> </ul>

STEP 7 - TIMER	
Press the "TIMER" Key to select your desired running time	
<b>2H</b> 2 Hours	<ul style="list-style-type: none"> <li>The unit will automatically switch off at the end of the selected time period.</li> </ul>
<b>4H</b> 4 Hours	<ul style="list-style-type: none"> <li>As the time counts down the LED lights will indicate the time remaining.</li> </ul>
<b>8H</b> 8 Hours	<ul style="list-style-type: none"> <li>When no "TIMER" is set (the LED is off), the unit will run based on the mode you have selected.</li> </ul>

STEP 9 - CHECK LIGHTS	
<b>Water Full Indicator</b>	<ul style="list-style-type: none"> <li>Lights up when water tank is full or not properly inserted.</li> </ul>
<b>Check Indicator</b>	<ul style="list-style-type: none"> <li>Filter needs cleaning.</li> <li>Dehumidifier needs to cool down. Switch OFF and leave for 30 minutes and turn on again. This is normal.</li> <li>In low humidity or temperature conditions.</li> <li>In high temperature condition over 40°C or low temperature below 1°C</li> </ul>
<p><b>TIP:</b> When the check light comes on, remove the plug from the socket. Move the unit to another room after it cools down or when conditions allows, follow Steps 1 and 3.</p>	

USEFUL INFORMATION
<ul style="list-style-type: none"> <li>When you first use the dehumidifier and periodically thereafter you may notice a smell coming from the dehumidifier. This is caused by the Zeolite desiccant material and is NOT a sign that the dehumidifier is faulty, nor is it harmful to humans or pets. Odour will reduce gradually, this is normal. Ventilate the room if necessary to reduce the odour.</li> </ul>
<ul style="list-style-type: none"> <li>The Zeolite absorbs odours from items such as cigarettes, cosmetics, hair sprays, building materials and new furniture and then when the desiccant is heated the smell is discharged into the room. (This smell has been described as being like a burning smell or a sour smell). This is normal and will NOT last long, nor is it a sign of a fault.</li> </ul>
<ul style="list-style-type: none"> <li>Once the power is restored after a power failure, the appliance will continue to operate at the selected settings prior to the power failure.</li> </ul>



# EMPTY WATER TANK

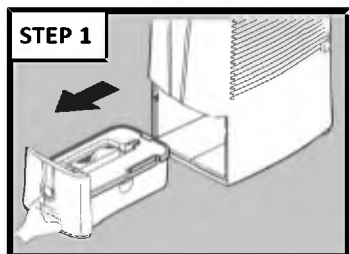

Pull water tank out

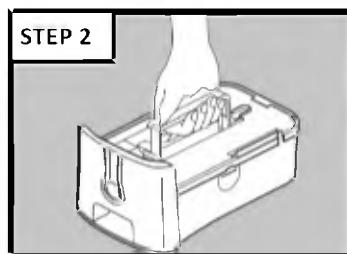

Lift by the handle

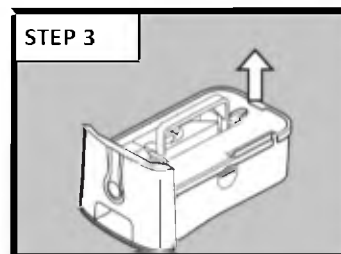

Remove the cover

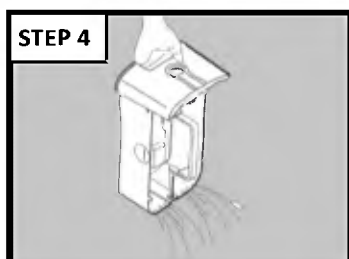

Pour the water away

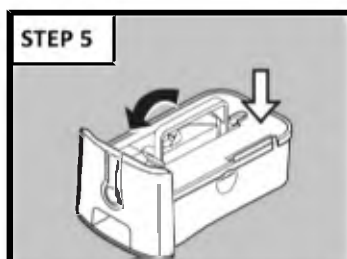

Restore the cover and the handle

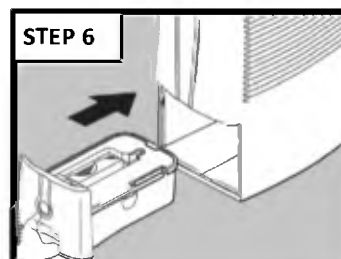

Insert the water tank

1. The Water Full Indicator lights up when the water tank is full and the unit stops operating.
2. Do not move the unit or remove the water tank when the dehumidifier is running, as water may leak; causing damages to the dehumidifier or an electric shock.
3. Before removing the water tank leave the dehumidifier to stand for approximately 10 minutes to ensure all water collected drips into the water tank.
4. To remove the water tank, pull it out gently by gripping the bottom of the water tank and lift carefully by the handle.
5. Remove the cover of the water tank, then pour the water away. Clean the water tank, restore the cover and handle.
6. Insert the water tank back to the correct position.

## NOTE :

- Clean the water tank with clean water if needed. Do not use detergent, solvent, abrasive or hot water to avoid damaging the dehumidifier.
- Do not remove or damage the float in the water tank or the dehumidifier will not operate properly.
- The Water Full light indicator illuminates if the water tank is not correctly in position.
- Do not tilt the dehumidifier when removing the water tank.

# CONTINUOUS DRAINAGE

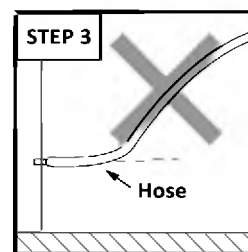
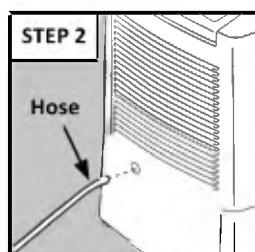
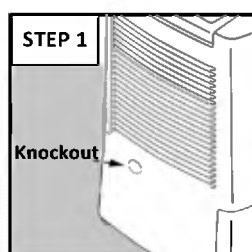

You may use a hose with an inner diameter of 12mm for continuous drainage:

1. Use a screwdriver to remove the knockout at the back. Attach the hose to the connector through the hole at the back of the dehumidifier.
2. The hose must lead to an appropriate drain at a downward slope with no sharp bends.

## NOTE:

- Ensure the water tank is well fitted in position before inserting the hose.
- Before removing the water tank, ensure that the hose is disconnected.

## STEP 1 - CLEANING YOUR FILTER

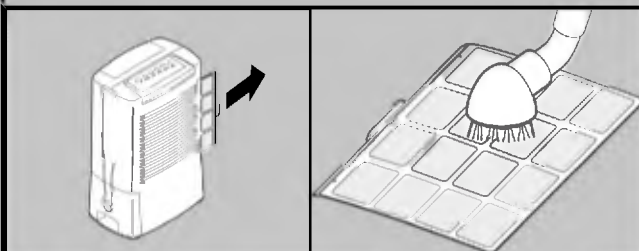

1. Turn OFF the dehumidifier and remove the filter from the unit.
2. Clean the filter with a brush or vacuum cleaner. (Washing will weaken the germicidal effect of the filter).
3. Replace the filter back into position.
4. If the filter is covered with dust, the airflow and the performance of the dehumidifier will be affected. Check the filter periodically to ensure all dust is removed.

**Tip:** Clean your filter every 2 weeks to keep your air clean and prolong the life of your dehumidifier. The frequency will depend on conditions of operation.

## STEP 2 - REPLACING YOUR FILTER

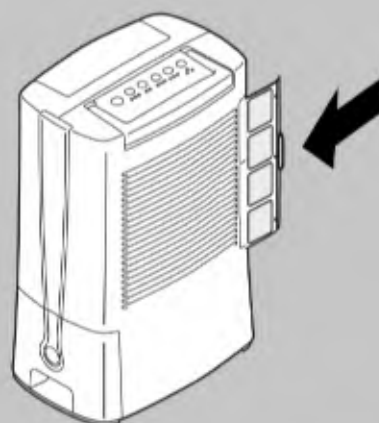

It is recommended that the filter is replaced every 1 - 2 years for optimal performance and hygiene standards. The frequency depends on the duration and conditions of operation. To purchase a replacement filter please visit:

[www.ecoairdirect.com](http://www.ecoairdirect.com)

## STEP 3- CLEANING YOUR DEHUMIDIFIER

1. Turn the dehumidifier OFF, wait for the fan to stop and unplug the unit from the socket.

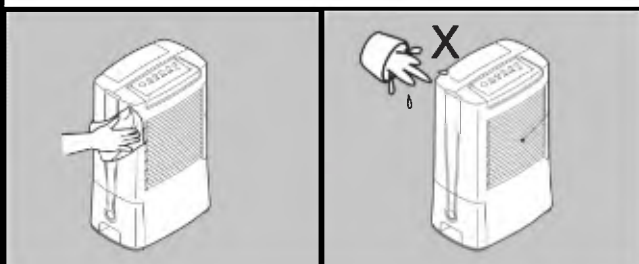

2. Clean the surface with a soft damp cloth.
3. Dry thoroughly with a towel after cleaning.
4. Empty the water tank. Allow water tank to drip dry or dry with a cloth.

**Caution:**



- Do not wash the unit or immerse in water.
- Do not let water drip into the air inlet or outlet.

## STEP 4 - STORING YOUR DEHUMIDIFIER

1. Turn OFF the dehumidifier, wait for the fan to stop and unplug the dehumidifier from the power socket.
2. Leave the dehumidifier to drain for approximately one day. Clean and dry the water tank.
3. Clean the filter and the dehumidifier. Cover the dehumidifier to prevent it from gathering dust. Store upright in a cool dry place.
4. Do not expose to direct sunlight.

# TROUBLESHOOTING

CHECK THE FOLLOWING POINTS BEFORE CONTACTING TECHNICAL SUPPORT.

PROBLEM	REASON	SOLUTION
No Power	Dehumidifier is not plugged in or there is no power supply	Plug the dehumidifier into mains and switch plug ON. Check the main power supply
 Check Light On	Filter clogged	Check and clean or replace the filter
	The air inlet or outlet is blocked or covered	Remove obstructions
	Low humidity condition	Switch off unit and move to another room
 Water Full Light On	Water tank is full or installed incorrectly	Empty water tank or re-install correctly
	Water float out of position	Restore water float back into position
Water Leaking	Dehumidifier on uneven surface or water tank fitted incorrectly	Ensure the dehumidifier is on a flat, even surface, use a spirit level to check, remove tank and replace correctly
	Filter clogged	Clean or replace filter
	Damaged water tank	Remove the water tank, fill with water and place on a hard even surface to test for leakage
	The continuous drainage is clogged or loose	Check the continuous drainage hose and its connection
Not Collecting Water	Set humidity is reached	Readjust the humidity settings
	Room is very cold or very dry for the current settings	Readjust the humidity setting or increase the room temperature
	Filter dusty	Clean the air filter or replace it
	Dehumidifier set up incorrectly	Ensure unit is set up correctly (Quick Start Up)
	Room Temperature is too hot Room Temperature is too cold	Open the window or door to ventilate Increase heat in the room
Noisy	Water tank or filter fitted incorrectly	Check and refit the water tank or filter Check unit is on an even level surface

In the unlikely event of a problem with your product, please refer in the first instance to:

**ECOAIR TECHNICAL SUPPORT**

[www.ecoair.org/support](http://www.ecoair.org/support)

## SPECIFICATIONS

MODEL	DD128
Temperature Range	1°C ~ 40°C
Dehumidification Extraction Rate	8 Litres day (20°C, 60%RH)
Water Tank Capacity	2.2 Litres
Voltage	220 - 240V~50Hz
Net Weight	6.1 Kg
Gross Weight	7.2 Kg
Net Dimension (W x H x D)	320mm x 476mm x 212mm
Gross Dimension (W x H x D)	391mm x 559mm x 259mm

EcoAir guarantees this product to be free from defects in materials and workmanship for a period of (2) years from the date of purchase. Coverage is valid only with proof of purchase.

## Warranty Terms and Conditions

The conditions below apply to our warranty. They do not affect your statutory rights or the obligations of your retailer and your contract with them.

We provide warranty cover for this appliance subject to the following conditions:

1. We will rectify defects affecting the appliance which are clearly attributable to material and/or manufacturing faults, provided they are reported immediately after being identified within the Warranty Period supported by proof of purchase.
2. Service may not be available to all the islands around the UK. Please check with your retailer or contact our customer service department.
3. The warranty will not extend to consumables such as air filters.
4. Warranty liability will not be triggered by minor variances from nominal features which are of no significance to the appliance's value or fitness for purpose, nor damage caused by wear and tear, exceptional environmental conditions and inappropriate operating conditions.
5. No warranty liability will be accepted:-
  - a. If the defects stem from transport damage for which we are not responsible.
  - b. Improper installation and assembly or non-compliance with the safety regulations and warnings given in the operating instructions.
  - c. Improper use, to also include poor maintenance caused by insufficient aftercare or cleaning and failure to observe operating or assembly instructions or use with improper voltage recommendations.
  - d. Use in a non-domestic environment, to include appliance for rental.
6. No rights are given under this warranty to a person acquiring the appliance second hand.
7. We reserve the right to invalidate the warranty: -
  - a. If repairs or other interventions are performed by persons not authorised by us.
  - b. If our appliances are fitted with non-original spare parts, extras or accessories.
  - c. If our appliance has been altered and damaged by owner or third parties.
  - d. In the event of abuse (whether physical or verbal abuse) towards any member of staff.
8. Warranty provision will be free of charge and we will decide whether this will take the form of a repair or the replacement of the appliance. Small appliances that can be reasonably transported or posted may need to be handed over or shipped to our customer service centre. A purchase receipt must be presented in each case. Replaced parts pass into our ownership.
9. Under no circumstances shall the application of this warranty give rise to the complete replacement of the appliances. In the event of a replacement appliance being supplied at our discretion, we reserve the right to charge an appropriate monetary offset in respect of the period of use already enjoyed.
10. The provision of services under warranty neither extends the term of the warranty nor sets in motion a new Warranty Period. The Warranty Period for spare parts fitted ends with the expiry of the warranty on the appliance as a whole.
11. EcoAir shall not be liable for loss of goods, loss of use, or any special, indirect, consequential or pure economic loss, costs, damages, charges or expenses.
12. Our Warranty service is on a return to base basis.
13. This unit is only for domestic use.
14. The Customer acknowledges and agrees that details of the Customer's name, address and payment method will be held and used by EcoAir to provide the services and to send to the Customer further information. EcoAir may disclose your information to third parties and agents in order to perform the services.

These warranty conditions apply to appliances purchased in the United Kingdom. If appliances shipped to other countries feature the appropriate technical conditions (e.g. voltage, frequency, gas-types etc.) for the climatic and environmental conditions in the country concerned, the terms of the warranty will apply, provided a local customer service network exists. Appliances purchased outside the United Kingdom are subject to the warranty conditions published by the appropriate local representative office of that country. These can be obtained via the specialist dealer from whom you bought appliance.