



X SERIES INVERTER RANGE SPLIT TYPE

DC Inverter

X SERIES 920SD WiFi

X SERIES 1220SD WiFi

X SERIES 1820SD WiFi

X SERIES 2420SD WiFi

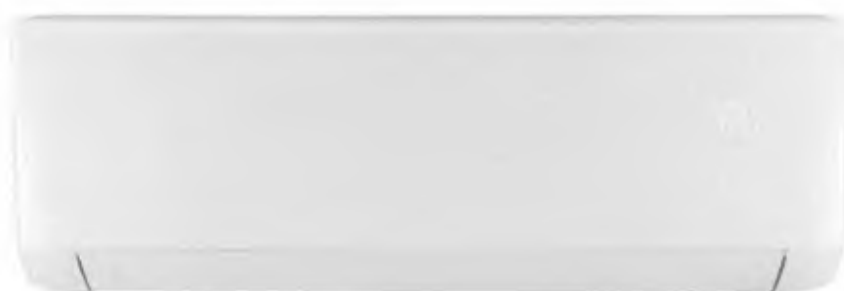

Register your air conditioner

Model information can be found on the CE label.

Please register your product online at www.ecoair.org. For future convenience, record the model information below.

Model Number

Serial Number

- 1 x X-Series Indoor Unit
- 1 x X-Series Outdoor Unit
- 1 x Remote Control
- 1 x Drain Hose
- 1 x User Manual
- 1 x Hole Cover Plate
- 1 x Drain Joint
- 4 x Wall Plugs and Screws
- 1 set of Copper Pipes

This appliance is not intended for use by persons (including children) with reduced physical, sensory or mental capabilities or lack of experience and knowledge, unless they have been given supervision or instruction concerning use of the appliance by a person responsible for their safety.

Children should be supervised to ensure they are away from the appliance.



WEE/EC2601UR

This marking indicates that this product should not be disposed with other household wastes throughout the EU. To prevent possible harm to the environment or human health from uncontrolled waste disposal, recycle it responsibly to promote the sustainable reuse of material resources. To return your used device, please use the return and collection systems or contact the retailer where the product was purchased. They can take this product for environmental safe recycling.

(R32/125: 50/50): 1975

Operation Notices

Important Safety Instructions	3
Parts	4

Screen Operation Guide

Set Up – Remote control.....	5
Introduction to buttons on the remote control.....	6-8
Summary of “Combination Buttons”	9
Emergency operation.....	10
Operation Guide	11
Replacement of batteries in the remote control.....	11

Maintenance

Care and Maintenance.....	12-13
---------------------------	-------

Malfunction

Troubleshooting.....	14
----------------------	----

Installation Notice

Installation dimension diagram.....	16
Tools for installation	17
Selection of installation location	17
Requirements for electrical connection	18

Installation

Installation of indoor unit	19-22
Installation of outdoor unit	23-25
Vacuum pumping	26
Leakage detection	26
Post Installation Check	27

Test and operation

Test operation	27
----------------------	----

Attachment

Install snow guard (Optional)	28
Configuration of connection pipe	29
Pipe expanding method	30
Warranty	31

IMPORTANT SAFETY INSTRUCTIONS

PLEASE READ ALL INSTRUCTIONS CAREFULLY BEFORE OPERATING.

WARNING!

This appliance is intended for domestic use only. Any other use is not recommended by the manufacturer as it may cause fire, electrical shocks or other injuries to person or property. Any installations must be carried out by an F-Gas engineer in accordance with EU regulations.

When using electrical appliances, basic safety precautions should always be followed:

1. Do not operate the appliance if there is a damaged cord, plug or after it malfunctions if it has been dropped or damaged in any way. Arrange for the appliance to be examined or repaired by an authorised technician.
2. Always keep the outdoor unit in an upright position to avoid any damage. Place the appliance on an even level surface during operation.
3. Ensure the household voltage matches the rated specification for the appliance before use.
4. Operate this appliance in an ambient temperature between 15°C and 43°C.
5. Ensure that the air inlets and outlets are not blocked or covered. Do not insert fingers or any objects into the air inlet or outlet openings.
6. Do not place the unit too close to curtains or any other objects, see manual.
7. Never place anything on top of the appliance and do not cover while in use.
8. To protect against electric shocks, do not immerse or spray the appliance or any of its parts in water.
9. Never unplug the power cord without switching OFF the appliance first.
10. Always disconnect the appliance when not in use or when moving location.
11. Close supervision is necessary when the appliance is used in the presence of children and pets.
12. Do not run power cord under carpeting, or cover with rugs or runners. Arrange the cord away from areas where it may become a trip hazard.
13. Never operate or store the appliance in direct sunlight.
14. Repairs must be carried out by an authorised F-Gas Engineer, failure to do so may cause damage to the appliance or injury to persons or property and will void the warranty. Always insist on original spare parts.
15. Do not connect via an extension lead or Multi-socket plug. Extension leads and Multi-socket plugs do not guarantee the required safety of the appliance (e.g. danger of overheating).
16. Do not use the appliance without the air filter. Clean or replace the air filter regularly.
17. At the end of its working life dispose of the appliance responsibly, in accordance with local regulations.
18. Before cleaning or maintaining the appliance, please turn off the power.
19. Do not handle the power chords with wet hands.
20. If the power cord is damaged, it must be replaced by the manufacturer or its approved service agent's or a similarly qualified F-Gas Engineer in order to avoid a hazard.
21. Do not insert any objects into the appliance.
22. Do not splash or pour water onto appliance. Otherwise, it may cause short circuit or damage to it.
23. Do not operate heating equipment around the appliance.
24. Keep a safe distance from fire source, inflammable and explosive objects.
25. Do not step on the top panel of the outdoor unit, or place heavy objects on top of it. This could cause damage or personal injury.
26. Do not put clothes above the appliance to dry.
27. Never open the unit casing yourself and attempt to repair. This will void the warranty and is a potential health and safety risk.
28. Keep the remote control in a dry place.
29. Do not block air outlet or air inlet as this may cause malfunction.
30. If you need to relocate your unit consult and employ a qualified F-Gas Engineer. Personal injury or damage could occur if these actions are not taken.
31. Your air conditioner should be correctly earthed. Incorrect earthing could cause electric shock and personal injury.
32. Ensure the correct circuit breaker and Isolators are installed according to building regulations, if not personal injury and malfunction could occur.

This appliance is not intended for use by persons (including children) with reduced physical, sensory or mental capabilities, unless they have been given supervision or instruction concerning use of the appliance by a person responsible for their safety. Children should be supervised to ensure that they do not play with the appliance.

READ & SAVE THESE IMPORTANT SAFETY INSTRUCTIONS FOR FUTURE REFERENCE

INDOOR UNIT

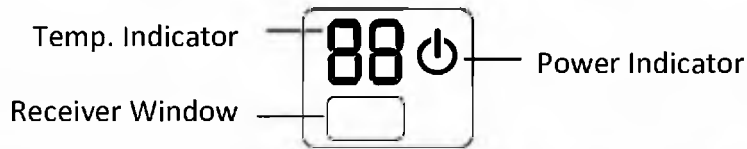
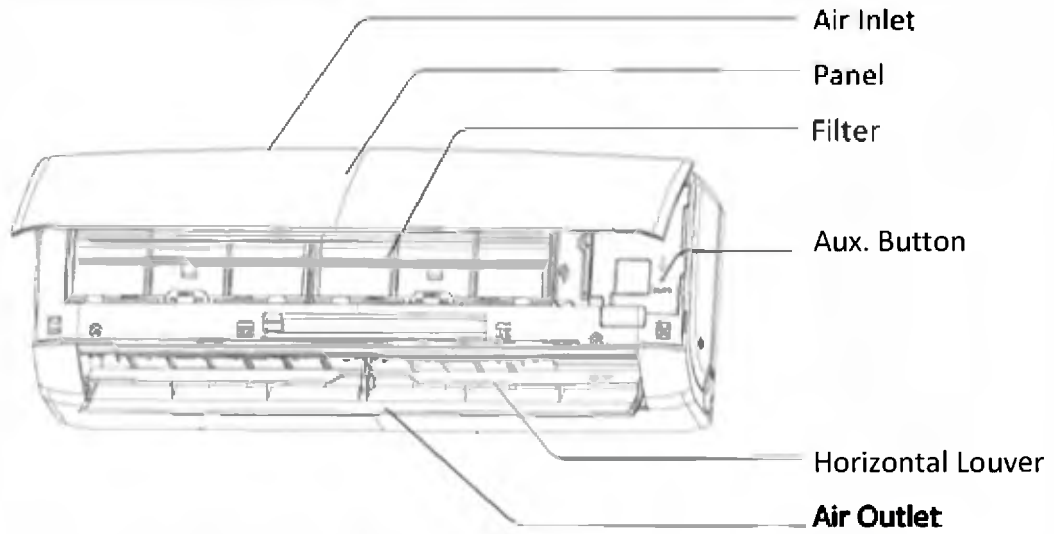

Remote Controller

(Display content or position may be different from above graphics, please refer to actual products)

OUTDOOR UNIT

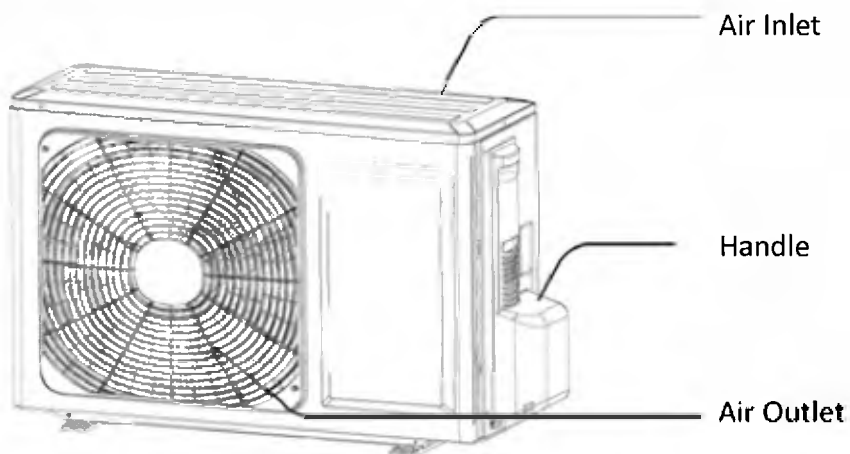

Actual product may be different from above graphics, please refer to actual products.

REMOTE CONTROL

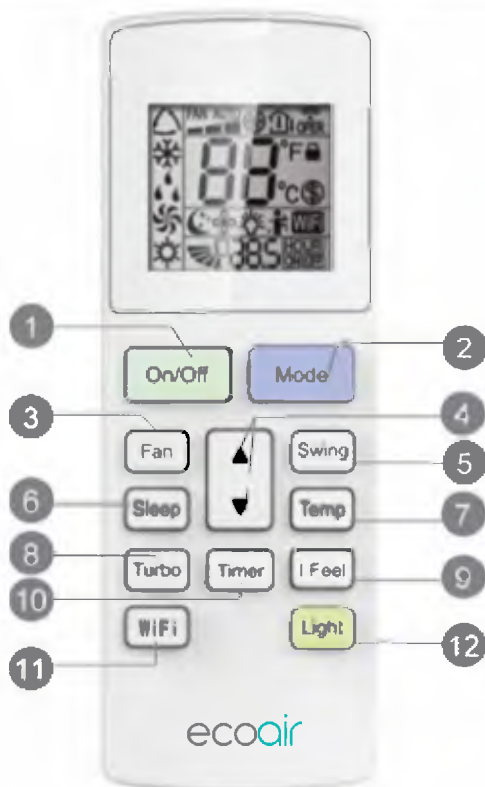

1. ON / OFF Button
2. Mode Button
3. Fan Button
4. SWING Button
5. Swing
6. Sleep Button
7. Temp Button
8. Turbo Button
9. I Feel Button
10. Timer Button
11. WiFi Button
12. Light Button

NOTICE: "WiFi" This is a general remote controller. Some models have this function while some do not. Please refer to the actual models.

USEFUL INFORMATIONS

- ◆ To operate, point the remote controller towards the indoor unit no more than 6 meters away.
- ◆ Make sure there is no obstacles between the remote control and the indoor unit.
- ◆ Remote control signal may be interfered within the room where there is wireless telephone, fluorescent lamp.
- ◆ When the air conditioner is not in use for a long time, please remove batteries from the remote controller.
- ◆ If there is no display on the remote control, please replace batteries.

REMOTE CONTROL DISPLAY SCREEN

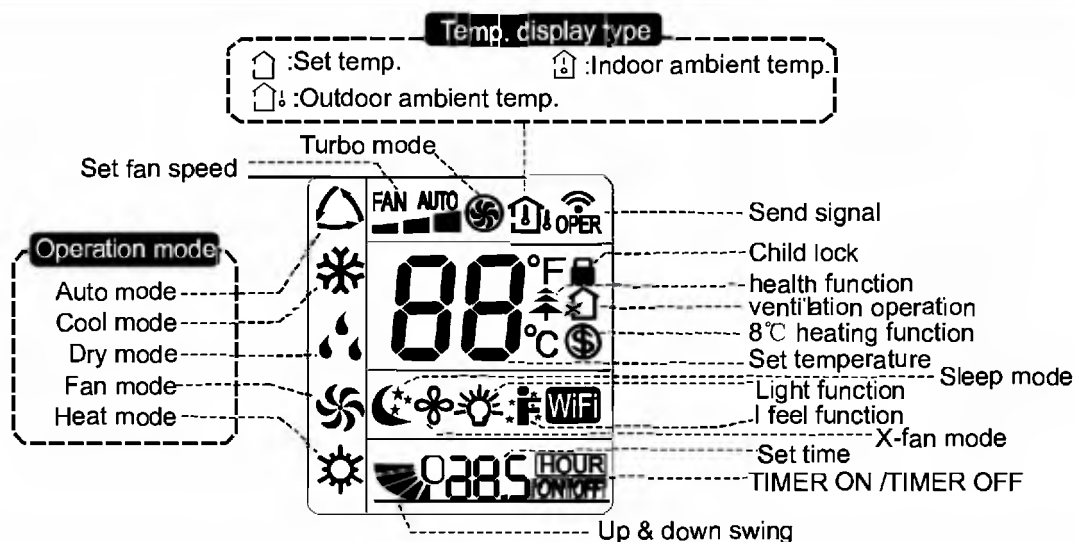

Note:

- ◆ You can operate the air conditioner via the remote control after turning on the Air Conditioner using the power button on the device itself.
- ◆ Whilst using the remote, ensure you are positioned close enough to the device. The signal icon "📶" on the remote control will flash once, you will also hear a "Beep" sound from unit itself. This indicates that a signal has been sent to the air conditioner.
- ◆ Whilst the remote controller is "OFF", the display screen on the remote control displays the set temperature. Whilst the remote controller is "ON" the display screen on the remote control will display the current settings that the air conditioning unit is currently set to.

1) ON/OFF Button

Press this button to turn the air conditioner on or off. Note that the indoor unit will also make a sound to confirm this status.

2) MODE Button

Press this button to select your required operation mode.



- **Auto Mode** -The air conditioner will operate automatically according to the ambient temperature in the room. The temperature cannot be adjusted or displayed in this mode. Press the "FAN" button to adjust the fan speed. Press "Swing" button to adjust the swing angle.
- **Cool Mode** - When the indicator on the remote shows "❄️" your unit will be on Cool Mode. You can press the "▲" or "▼" button to adjust or set the temperature. Press the "FAN" button to adjust the fan speed. Press the "Swing" button to adjust swing angle.
- **Dry Mode** - The air conditioner will begin to operate at a low speed. The dry indicator "💧" will show on the remote controller. In dry mode, the fan speed cannot be adjusted. Press the "Swing" button to adjust the swing angle.
- **Fan Mode** - The air conditioner operates solely in this mode. All mode indicators on the indoor unit will show OFF, however the operation indicator will show ON. Pressing the "FAN" button can adjust fan speed. Press "Swing" button to adjust the swing angle.
- **Heat Mode** – The Heat indicator "☀️" will show when selecting this function. You can press the "▲" or "▼" button to adjust or set the temperature. Press the "FAN" button to adjust fan speed. Press "Swing" button to adjust the swing angle

Note:

- * For preventing cold airflow, after selecting the Heat Mode, the indoor fan will not blow for a period of 1-5min. (This time is determined by your indoor ambient temperature)
- * The temperature range you can select between is from 16°C to 30°C degrees.
- * Fan speed can also be adjusted to Auto, Low, Medium or High.

3) Fan Button

This button is used for setting Fan Speed from AUTO to , to  to , then back to Auto.

* In AUTO mode fan speed will alternate between Low, Medium or High based on your ambient

4) ▲ / ▼ Button

Press ▲ / ▼ button to increase/decrease the set temperature. In AUTO mode, the set temperature is NOT adjustable.

When setting Timer On or Timer Off, press ▲ or ▼ button to adjust the time.

5) Swing Button

Press this button to change the swing angle of the air louver to direct airflow.

6) Sleep Button



Under Cool or Heat mode, press this button to turn on the Sleep function. In Sleep Mode the pre-set temperature will increase by 2 degrees (Cool Mode) or decrease by 2 degrees (Heat Mode) after 2 hours from setting. Press this button again to cancel the Sleep function.

* Under Fan Dry and Auto modes, this function is unavailable.

7) Temp Button

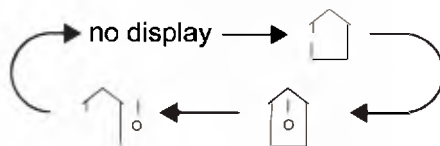
Press this button to see the indoor set temperature, indoor ambient temperature on the indoor unit's display. The setting on remote controller is selected circularly as below:



- When selecting the "  " the display will show the set temperature. This will be displayed on both the indoor unit and the remote control.
- When selecting the "  " the display will show the ambient indoor temperature. This will be displayed on both the indoor unit and the remote control.
- When selecting the "  " the display will show the outdoor temperature. This will be displayed on both the indoor unit and the remote control.

Note:

Outdoor temperature display is not available for some models. At that time, indoor unit receives "  " signal, while it displays indoor set temperature.

8) Turbo Button

Press this button to activate / deactivate the Turbo function Under COOL or HEAT mode.

9) I Feel Button

Press this button to start I FEEL function and ".F" will be displayed on the remote controller. After this function is set, the remote controller will send the detected ambient temperature to the controller and the unit will automatically adjust the indoor temperature according to the detected temperature. Press this button again to close I FEEL function and ".F" will disappear.

- When I FEEL function is turned on, the remote controller should be positioned within the area where the indoor unit can receive the signal sent by the remote controller.

* IFEEL function is not available on all models.

10) Timer Button

- Whilst remote is "ON" press this button to set timer OFF(HOURS OFF); Whilst "OFF" press this button to set timer ON (HOURS ON).
- Press " ▲ " or " ▼ " button to adjust timer setting (time will change quickly if holding " ▲ " or " ▼ " button). Time setting range is 0.5-24hours. Press this button again to confirm timer setting and the characters of HOUR ON (OFF) will stop flashing. If the characters are flashing but you haven't pressed the timer button, the timer setting status will quit after 5s. If the timer is confirmed, press this button again to cancel timer.

11) WiFi Button

Press " WiFi " button to the WiFi function on or off. When the WiFi function is turned on, the " WiFi " icon will be displayed on remote controller;

- This function is only available for some models.
- In order to connect a handheld smartphone, tablet or laptop please visit ecoair.org for further instructions.

12) Light Button

Press this button to turn on the display's light and press this button again to turn off the display's light.

SUMMARY OF "COMBINATION BUTTONS"

Combination of " ▲ " and " ▼ " button: Child Lock

Press " ▲ " and " ▼ " buttons simultaneously for 3s to lock or unlock the keypad. If the remote controller is locked,  is displayed.

Combination of "MODE" and " ▼ " buttons: °C and °F

Whilst remote is "OFF", press the "Mode" and " ▼ " button simultaneously to switch between °C and °F

Combination of "TEMP" and "TIMER" buttons: Energy-Saving Function

Press "TEMP" and "Timer" button simultaneously in COOL mode to start energy-saving function. The remote controller will display "SE". Repeat the operation to quit the function

* Not all models have this function

Combination of "TEMP" and "TIMER" buttons: About 8 °C Heating Function

Press "TEMP" and "TIMER" simultaneously in HEAT mode to start 8 °C Heating Function

The remote controller displays "  " and a selected temperature of "8 °C". Repeat the operation to quit the function.

* Not all models have this function

Emergency Operation

If the remote control is lost or damaged, please use the auxiliary button on the indoor unit to turn the appliance on or off. (As shown below)

As shown below, Open the front panel on the indoor unit, press the aux. button to turn the unit on or off. When the air conditioner is turned on, it will operate in auto mode.

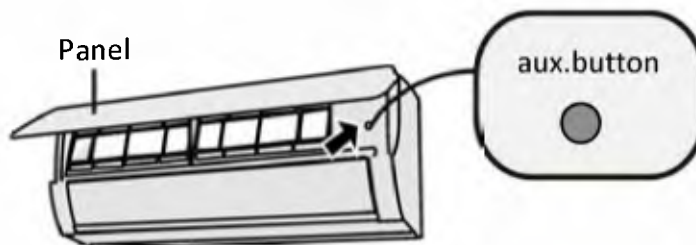

Care and Maintenance

Note:

- Turn off the air conditioner and disconnect the power before cleaning to avoid personal injury by electric shock.
- Do not wash the air conditioner with water to avoid personal injury by electric shock.
- Do not use volatile liquids to clean the air conditioner.

CLEANING THE SURFACE OF THE INDOOR UNIT

If the surface of your unit is dirty we recommend that you use a soft dry cloth to clean. A slightly damp cloth could be used for more stubborn dust and dirt.

Note: Do not remove the panel when cleaning it.

Operation Guide

- After you have connected the unit, press “**ON/OFF**” button on the remote control to turn the air conditioner on.
- Press the “**MODE**” button to select your required mode: AUTO, COOL, DRY, FAN, HEAT.
- Press “**▲**” or “**▼**” button to set your required temperature. (Temperature can't be adjusted under auto mode).
- Press “**FAN**” button to set your required fan speed: auto, low, medium and high speed.
- Press “**SWING**” button to change the swing angle of the air louver to direct airflow.

Replacement of batteries in the remote control

1. Press and slide the back cover of the remote control mark with “” as shown apposite. Push out the cover of the battery compartment in the direction of the arrow.
2. Replace 2 x AAA (1.5V) batteries, making sure the position of the “+” polar and “-” polar are correct
3. Reinstall the cover of the battery compartment.

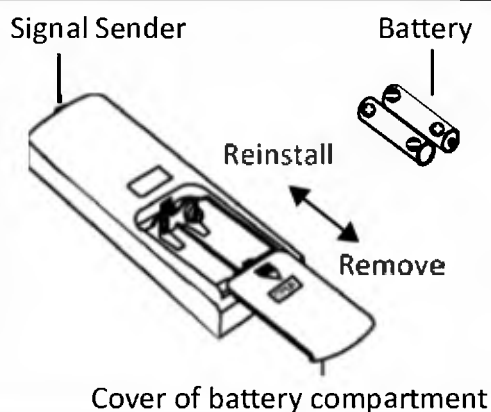

NOTE:

- During operation, point the remote-control signal sender at the receiving window on the indoor unit.
- The distance between signal sender and receiving window should be no more than 6m, and there should be no obstacles between them.
- Signal may be interfered easily in the room where there is a fluorescent lamp or wireless telephone; the remote control should be within close proximity to the indoor unit during operation.
- Replace new batteries of the same model when replacement is required.
- When you do not plan on using the remote control for a long time, please remove the batteries.
- If the display on remote control is fuzzy or there's no display, please Replace the batteries.

Clean Filter

1 Open panel

Pull out the panel to a certain angle as shown in the fig.



2 Remove filter

Remove the filter as indicated in the fig.

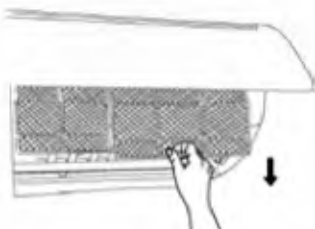

3 Clean filter

- Use dust catcher or water to clean the filter.
- When the filter is very dirty, use the water (below 45°C) to clean it, and then put it in a shady and cool place to dry.

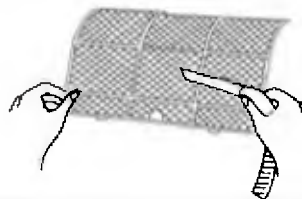

4 Install filter

Install the filter and then close the panel cover tightly.



NOTE:

- The filter should be cleaned every three months. If there is a large amount of dust in the operating environment , check and clean more frequently.
- After removing the filter, do not touch the fins to avoid injury
- Do not use fire or a hair dryer to dry the filter it can cause deformation.

Checks before use

1. Check whether air inlets and air outlets are blocked.
2. Check whether the circuit breaker, plugs and sockets are in good condition.
3. Check whether the filter is clean
4. Check whether the mounting bracket for the outdoor unit is damaged or corroded. If yes, please contact a qualified engineer.
5. Check whether the drainage pipe is damaged.

Checks after use

1. Disconnect power supply.
2. Clean filter and indoor unit's panel.
3. Check whether mounting bracket for outdoor unit is damaged or corroded. If yes, please contact a qualified engineer..

NOTICE FOR RECOVERY:

- Many packing materials are recyclable materials. Please dispose of them using an appropriate recycling method.
- If you want to dispose of the air conditioner, please contact your local authority or service center for the correct disposal method.

PROBLEM	REASON	SOLUTION
Indoor unit can't receive remote controller's signal or remote controller has no action.	Whether it's severely interfered (such as static electricity or unstable voltage)?	Pull out the plug. Reinsert the plug after about 3 min, and then turn the unit on again.
	Whether the remote controller is within the signal receiving range?	Signal receiving range is 6m.
	Whether there are obstacles?	Remove obstacles.
	Whether the remote controller is pointing at the receiving window?	Using a different angle, point the remote controller at the receiving window on the indoor unit.
	Is the sensitivity of remote controller low; do you see a fuzzy display or no display?	Check the batteries. If the power of the batteries is too low, please replace them.
	No display when operating remote controller?	Check whether the remote controller appears to be damaged. If yes, replace it.
	Fluorescent lamp in room?	<ul style="list-style-type: none"> • Take the remote controller closer to the indoor unit. • Turn off the fluorescent lamp and then try it again.
No air emitted from indoor unit	Air inlet or air outlet of indoor unit is blocked	Eliminate obstacles.
	Under heating mode, indoor temperature has reached to set temperature?	After reaching set temperature, the indoor unit will stop blowing out air.
	Heating mode has just turned on	To prevent cold air expelling in heat mode, the indoor unit will start after a short delay. This is a normal phenomenon.
Air conditioner won't operate	Power failure?	Wait until power recovery.
	Appliance does not respond to the remote control.	Replace the batteries.
	Wiring has malfunction?	Ask qualified engineer to re-wire.
	Check the setting on the remote controller is correct?	Reset the settings.

PROBLEM	REASON	SOLUTION
Mist is emitted from the indoor unit's air outlet	Indoor temperature and humidity is high?	This is a natural occurrence. After a while indoor temperature and humidity will decrease, and the mist will disappear.
Set temperature can't be adjusted	Unit is operating under auto mode?	Temperature can't be adjusted under auto mode. Please switch to operation mode if you need to adjust temperature.
	Your required temperature exceeds the set temperature range?	Set temperature range: 16°C ~ 30°C .
Cooling (heating) effect is not good.	Voltage is too low?	Wait until the voltage resumes normal.
	Filter is dirty?	Clean the filter.
	Door and window are open?	Close door and window.
	Set temperature is in proper range?	Adjust temperature to proper range.
Odours are emitted	Check the odour's source, it might be coming from external source	<ul style="list-style-type: none"> • Eliminate the odour source. • Clean the filter
Air conditioner operates normally suddenly	Whether there's interference, such as thunder, wireless devices, etc.	Disconnect power, put back power, and then turn on the unit again
Outdoor unit has vapor	Heating mode is turned on?	During defrosting under heating mode, it may generate vapor, which is a normal phenomenon.
Water flowing noise	Air conditioner has just turned on/off ?	The noise is the sound of refrigerant flowing inside the unit, which is a normal phenomenon
Cracking noise	Air conditioner has just turned on/off ?	This is the sound of friction caused by expansion and/or contraction of panel or other parts due to the change of temperature.

Installation Dimensions

* For illustration purposes only

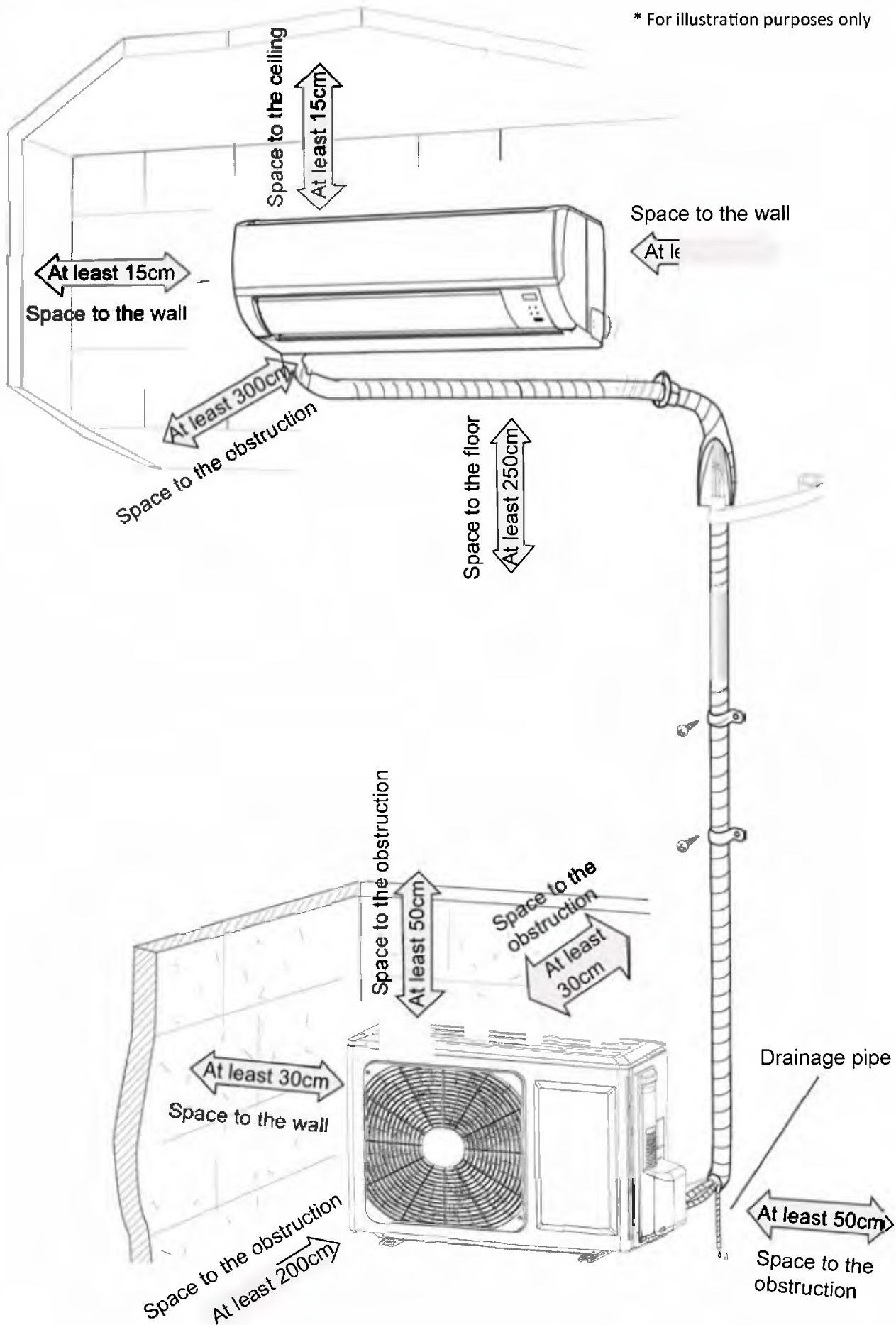

Note: Please use a qualified F-GAS Engineer for installation

Tools of installation

1) Level Meter	2) Screw Driver	3) Impact Drill
4) Drill Head	5) Pipe expander	6) Torque Wrench
7) Open-end Wrench	8) Pipe Cutter	9) Leakage Detector
10) Vacuum Pump	11) Pressure Meter	12) Universal Meter
13) Inner Hexagon Spanner	14) Measuring tape	

Selection of installation location

Basic Requirement

Installing the unit in the following places may cause malfunction. If it is unavoidable, please consult your F-GAS Engineer:

1. The place has strong heat sources, vapors, flammable or explosive gas, or volatile objects spreading through the air.
2. The place has close proximity to high-frequency devices (such as welding machines, medical equipment).
3. The place is near a coastal area.
4. The place has oil or fumes in the air
5. The place has sulfured gas in the air.
6. Other places with special circumstances.
7. The appliance should not be installed inside a bathroom or wet room.

Indoor Unit

1. There should be no obstruction near the air inlet and air outlet.
2. Select a location where the condensation water can be dispersed easily and will not affect other people.
3. Select a location which is convenient to connect the outdoor unit.
4. Select a location which is out of reach of children.
5. The location should be able to withstand the weight of the indoor unit and won't increase the noise and vibration.
6. The appliance must be installed 2.5m above floor.
7. Don't install the indoor unit above another electric appliance.
8. Keep the unit clear of fluorescent lamps.

Outdoor Unit

1. Select a location where the noise and outflow air emitted by the outdoor unit will not affect neighbors' or members of the public.
2. The location should be well ventilated and dry, in which the outdoor unit won't be exposed directly to sunlight or strong wind.
3. The location should be able to withstand the weight of outdoor unit.
4. Make sure that the installation follows the requirements set on the dimension diagram.
5. Select a location which is out of reach of children and far away from animals or plants. If it is unavoidable, please add a fence or cage for safety purposes.
6. EcoAir recommends that you seek permission from your local authority before any installation.

Requirements for electrical connection

Safety precaution

1. You must follow the national electrical safety regulations when installing the unit.
2. Use the correct power supply according to the specification.
3. Make sure the power supply matches with the requirement of the air conditioner. Improper power supply will cause malfunction to the unit. Please use correct power supply cables for the air conditioner.
4. All electrical work should be carried out by a qualified engineer/electrician
5. Be sure to cut off the power supply before carrying out any work related to electricity and service.
6. Do not power up the unit before completing the installation.
7. If the supply cable is damaged, it must be replaced by a qualified engineer/electrician to avoid a hazard.
8. If the temperature of the refrigerant circuit is high, please keep the interconnection cable away from the copper tube.
9. The appliance shall be installed in accordance with national wiring regulations.
10. Installation must be performed in accordance with local regulations and by a qualified electrician.

Earthing requirement

1. Split air conditioners are Class 1 electrical appliances. It must be properly earthed with a specialized grounding device by a qualified electrician. Please make sure it is always earthed effectively, otherwise it may cause electric shock.
2. The yellow-green wire in the split air conditioner is an earth wire, which can't be used for other purposes.
3. The earthing resistance should comply with national electric safety regulations.
4. The appliance must be positioned so that the power isolator is accessible.
5. An all-pole disconnection switch having a contact separation of at least 3mm in all poles should be connected in fixed wiring
6. Include a circuit breaker with suitable capacity, please note the following table. Circuit breakers should include a magnet buckle with a heating buckle function, it can protect against short-circuits

Air-conditioner	Circuit break capacity
09K、12K	16A (C Rated)
18K、24K	25A (C Rated)

Installation of indoor unit

Step one: choosing an installation location

Choose a suitable locations as recommended by your qualified F-GAS engineer.

Step two: install wall-mounting frame

1. Hang the wall-mounting frame on the wall; adjust it in a horizontal position with a spirit level and then mark the screw fixing holes on the wall.
2. Drill the screw fixing holes on the wall with an impact drill (the specification of drill head should be the same as the plastic wall plug that fits into the hole).
3. Fix the wall-mounting frame on the wall with tapping screws (ST4.2X25TA) and then check if the frame is firmly installed by pulling the frame. If the wall plug is loose, please drill another fixing hole nearby.

Step three: Drilling a hole for the communication cable and condensing hose

1. Choose the position of the piping hole according to the direction of the outlet pipe. The position of the piping hole should be a little lower than the wall-mounted frame, shown below.

X SERIES 920 & X SERIES 1220

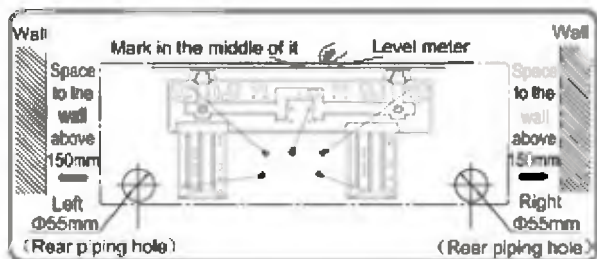

X SERIES 1820

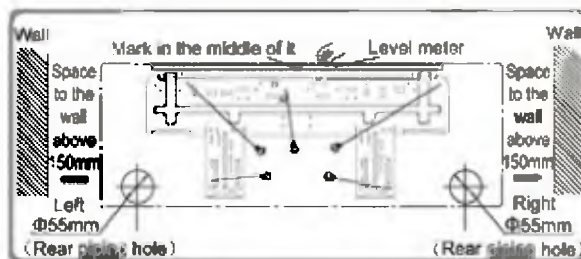

X SERIES 2420

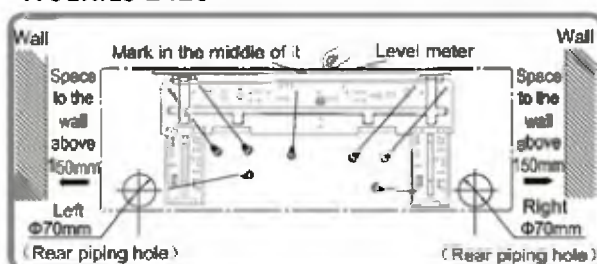

2. Open a piping hole with the diameter of $\Phi 55/70$ on the selected outlet pipe position. To drain water smoothly, slant the piping hole on the wall slightly downward to the outdoor side with the gradient of 5-10°.

Piping hole	Model
$\Phi 55$	Cooling capacity < 6000W
$\Phi 70$	Cooling capacity \geq 6000W

Note:

- Pay attention to dust prevention and take relevant safety measures when drilling the hole.

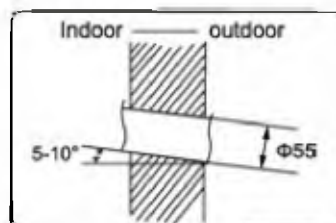

Installation of indoor unit

Step four: outlet pipe

1. The pipe can be led out via the following directions; right or rear right, left or rear left.

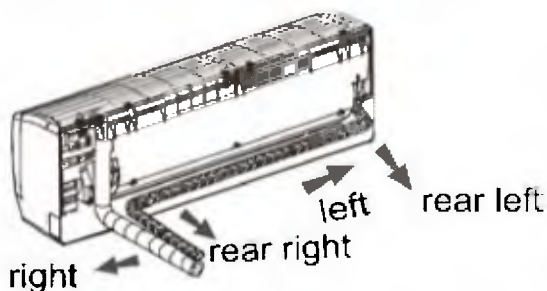

2. When leading out the pipe from the left or right, please cut off the corresponding hole on the bottom of the case.

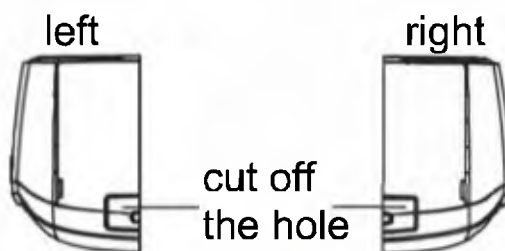

Step five: connect the pipe of indoor unit

1. Aim the pipe joint at the corresponding bell mouth
2. Pre-tightening the union nut with your hand
3. Please do not put any putty or PDF Tape on the threads it will react with the refrigerant and result to leaks and contamination of the refrigerant.

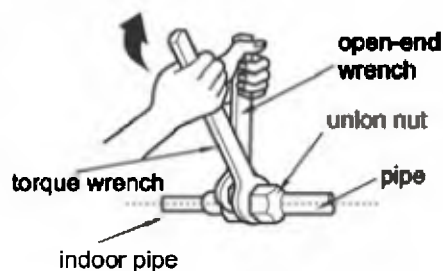
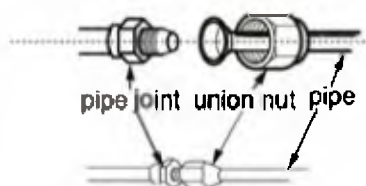

Hex nut diameter	Tightening torque (N·m)
Φ 6	15~20
Φ 9.52	30~40
Φ 12	45~55
Φ 16	60~65
Φ 19	70~75

4. Adjust the torque force by referring to the above sheet. Place the open-end wrench on the pipe joint and place the torque wrench on the union nut. Tighten the union nut with the torque wrench.

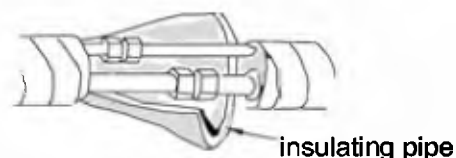

Step six: install drain hose

1. Connect the drain hose to the outlet pipe of the indoor unit.
2. Bind the joint with tape.

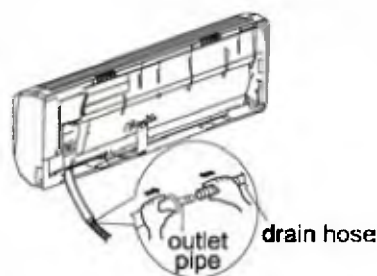
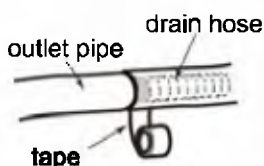

Note:

Add insulating pipe on the indoor drain hose in order to prevent condensation

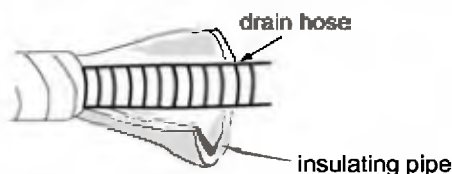

Installation of indoor unit

Step seven: connecting the wire to the indoor unit

1. Open the panel, remove the screw on the wiring cover and then take out the cover.
2. Make the power connection wire go through the cable-cross hole at the back of the indoor unit and then pull it out from the front side.
3. Remove the wire clip; connect the power connection wire to the wiring terminal according to the color; tighten the screw and then fix the power connection wire with the wire clip as shown below.

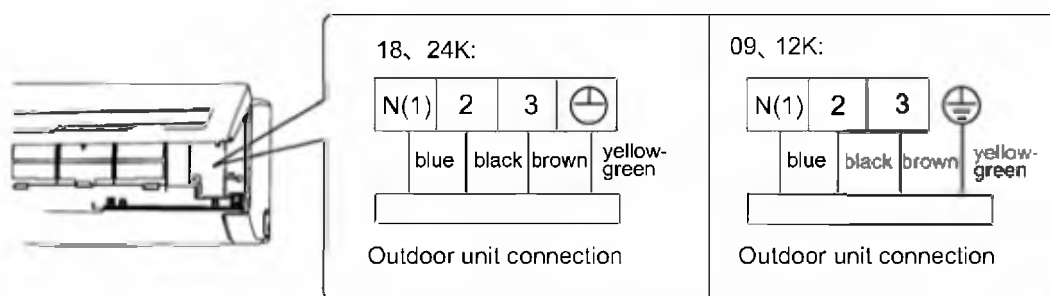
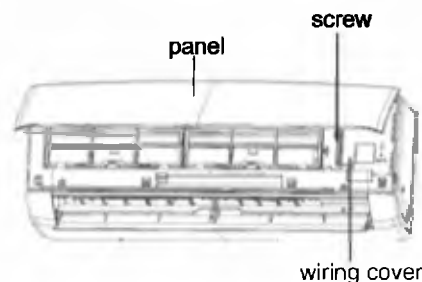

4. Put the wiring cover back and then tighten the screw.
5. Close the panel.

Note:

- All wires of the indoor unit and outdoor unit should be connected by a qualified F-GAS Engineer.
- If the length of power connection wire is insufficient, please contact the supplier for a new one. Avoid extending the wire by yourself.

Step eight: banding the pipes

1. Banding the connection pipe, power cord and drain hose.

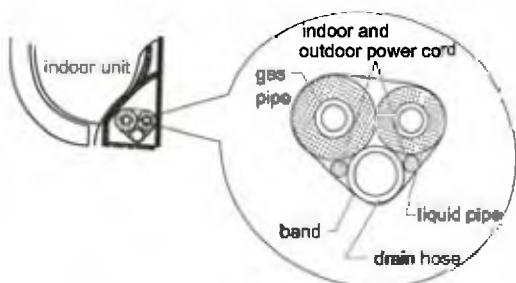

2. Reserve a certain length of the drain hose and power cord for installation when binding them. When binding to a certain degree, separate the indoor power and then separate the drain hose.

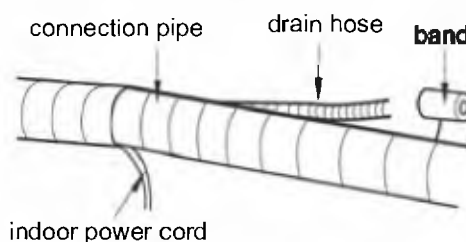

3. Bind them evenly.
4. The liquid pipe and gas pipe should be bound separately at the end.

Note:

- The power cord and control wire cant be crossed or winding.
- The drain hose should be bound at the bottom.

Step nine: hanging the indoor unit

1. Pass pipe through the hole in the wall.
2. Hang the indoor unit on the wall-mounting frame.
3. Stuff the gap between pipes and wall hole with a sealing gum.
4. Fix the hole cover plate.
5. Check if the indoor unit is installed firmly and close to the wall.

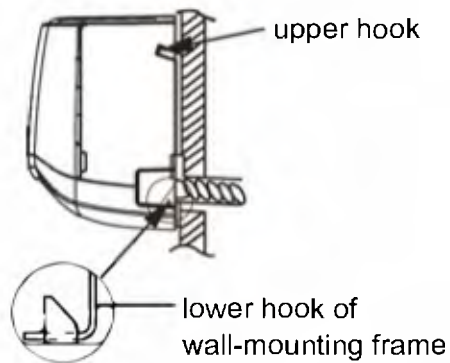
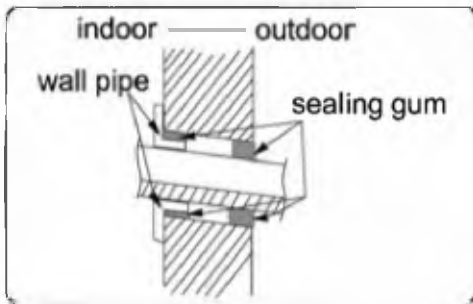

Note:

- Do not bend the drain hose too excessively this can cause blocking.

Step one

1. Select installation location according to the house structure.
2. Fix the support of the outdoor unit on the selected location with expansion bolts.

Note:

- Take sufficient protective measures when installing the outdoor unit.
- Make sure the support can withstand at least four times of the unit weight.
- The outdoor unit should be installed at least 2cm above the floor in order to install drain joints.

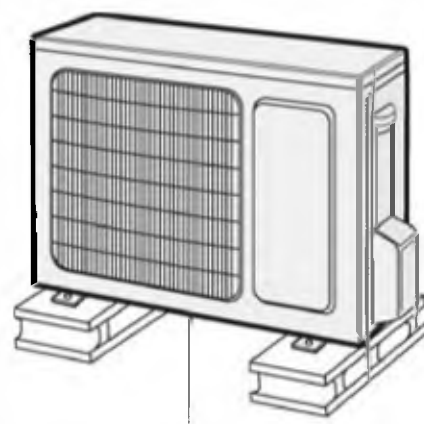

At least 2cm above the floor

Step two: install drain joint (Only for cooling and heating unit)

1. Connect the outdoor drain joint into the hole on the chassis, as shown in the picture below.
2. Connect the drain hose into the drain vent.

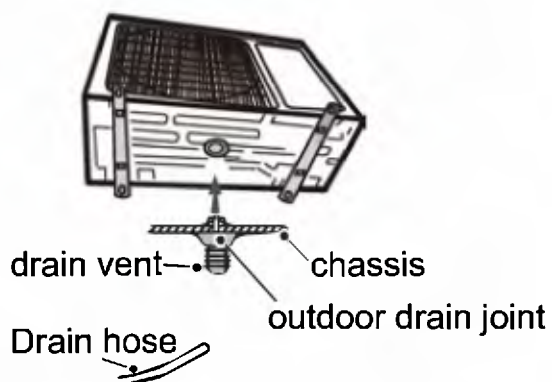

Step three: fix outdoor unit

1. Place the outdoor unit on the support.
2. Fix the foot holes of the outdoor unit with bolts.

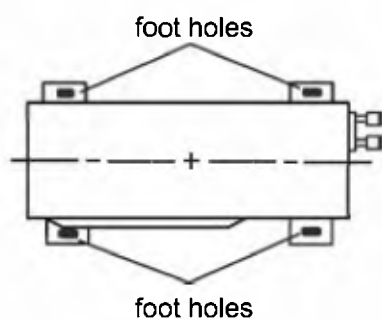

Installation of outdoor unit

Step four: connecting indoor and outdoor pipes

1. Remove the screw on the right handle of the outdoor unit and then remove the handle.

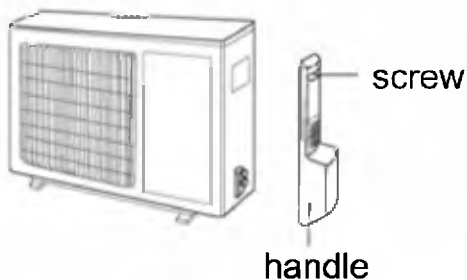

2. Remove the screw cap of the valve and aim the pipe joint at the bell mouth of pipe.

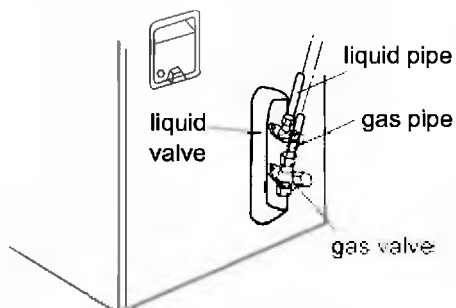

3. Pre-tightening the union nut with your hand.

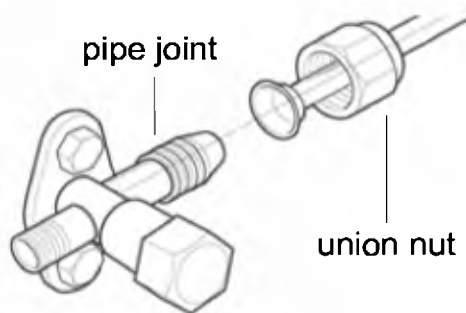

4. Tighten the union nut with torque wrench by referring to the sheet below.

Hex nut diameter	Tightening torque
Φ 6	15~20
Φ 9.52	30~40
Φ 12	40~55
Φ 16	60~65
Φ 19	70~75

Step five: connect outdoor electric wire

1. Remove the wire clip; connect the power connection wire and the signal control wire (only for cooling and heating unit) to the wiring terminal according to the color, fix them with screws

Note: the wiring board is for reference purpose, please refer to the actual unit

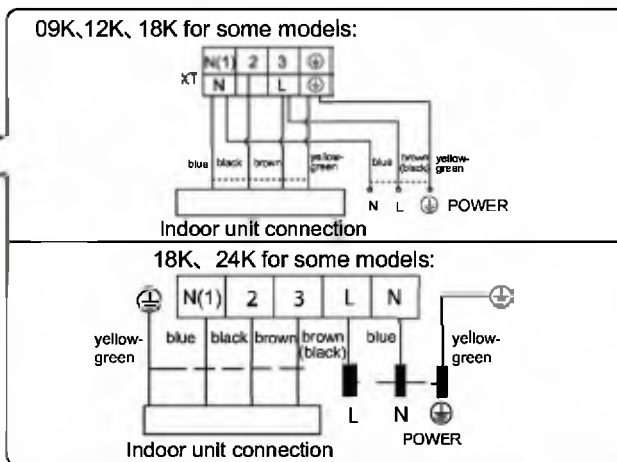
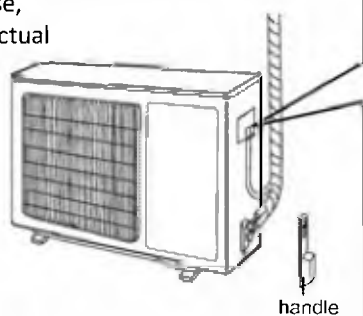

2. Fix the power connection wire and signal control wire with wire clip (only for cooling and heating unit).

Note:

- After tightening the screw, pull the power cord slightly to check if it is firm.
- Never cut the power connection wire to prolong or shorten the distance.
- EcoAir recommends this to be carried out by an F-GAS Engineer.

Installation of outdoor unit

Step six: Secure pipes

1. The pipes should be placed along the wall, bent reasonably and hidden possibly. Minimum semi-diameter of bending the pipe is 10cm.
2. If the outdoor unit is higher than the wall hole, you must set a U-shaped curve in the pipe before the pipe goes into the room, to prevent rain from getting into the room.

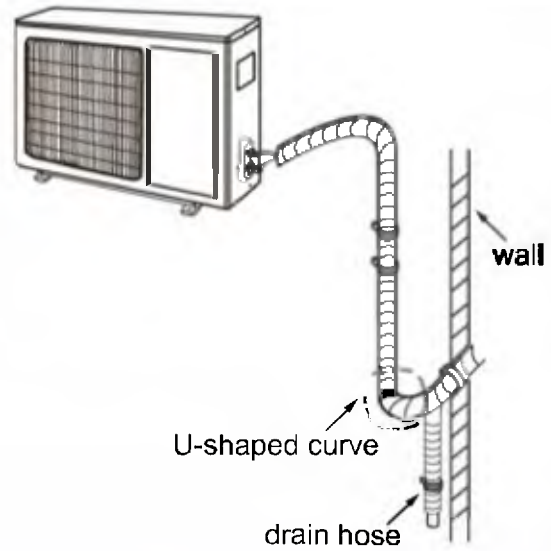

Note:

- The drain hose shouldn't be higher than the outlet pipe hole of the indoor unit.

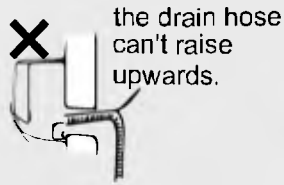

- The water outlet can't be placed in water in order to drain smoothly.

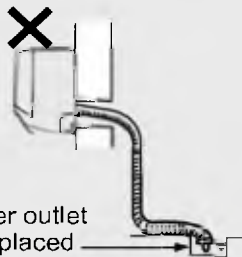

- Slant the drain hose slightly downwards. The drain hose can't be curved, raised and fluctuant, etc.

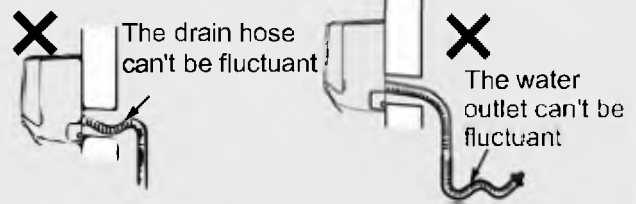
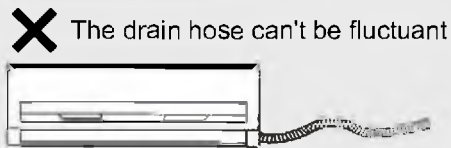
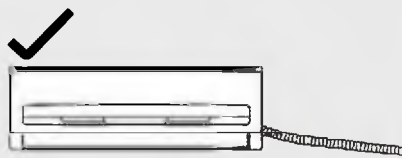

Using the vacuum pump

1. Remove the valve caps on the liquid valve and gas valve and the nut of the refrigerant charging vent.
2. Connect the charging hose of the piezometer to the refrigerant charging vent of gas valve and then connect the other charging hose to the vacuum pump.
3. Open the piezometer completely and operate for at least 30min to check if the pressure of piezometer remains in -0.1MPa .
4. Close the vacuum pump and maintain this status for 1-2min to check if the pressure of piezometer remains in -0.1MPa . If the pressure decreases, there may be leakage.
5. Remove the piezometer, open the valve core of liquid valve and gas valve completely with inner hexagon spanner.
6. Tighten the screw caps of valves and refrigerant charging vent.

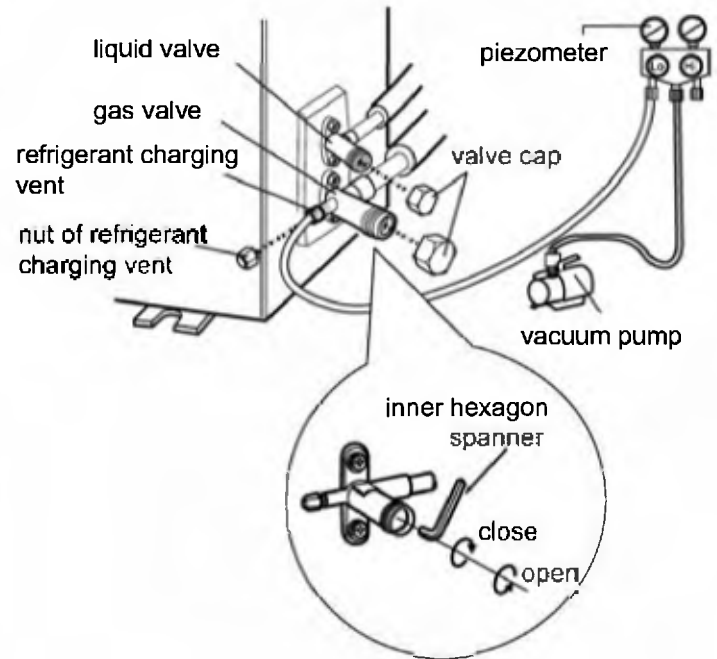

Leakage detection

1. **With leakage detector:**
Check if there is leakage with a leakage detector.
2. **With soap water:**
If leakage detector is not available, please use soap water for leakage detection. Apply soap water at the suspected position and keep the soap water for more than 3min. If there are air bubbles coming out of this position, there's a leakage.

Post Installation Checks

After installation is complete check the following requirements

Items to be checked	Possible malfunction
Has the unit been installed firmly?	The unit may drop, shake or emit noise.
Have you done the refrigerant leakage test?	It may cause insufficient cooling (heating) capacity.
Is heat insulation of the pipeline sufficient?	It may cause condensation and water dripping.
Is water drained well?	It may cause condensation and water dripping.
Is the voltage of the power supply according to the voltage marked on the nameplate?	It may cause malfunction or damage to the internal parts.
Is the electric wiring and pipeline installed correctly?	It may cause malfunction or damage to the internal components.
Is the unit earthed securely?	It may cause electric leakage.
Does the power cord follow the specification?	It may cause malfunction or damage to the internal components.
Is there any obstruction in the air inlet and outlet?	It may cause the unit to insufficiently cool or heat.
The dust and sundries caused during installation are removed?	It may cause malfunction or damage the internal components.
The gas valve and liquid valve of the connection pipe are open completely?	It may cause the unit to insufficiently cool or heat.

Test operation

1. Preparation of test operation

- The client approves the air conditioner.
- Specify the important notes of the split air conditioner to the client.

2. Method of test operation

- Connect the power, press ON/OFF button on the remote controller to start operation.
- Press MODE button to select AUTO, COOL, DRY, FAN and HEAT to check whether the operation is normal or not.
- If the ambient temperature is lower than 16°C , the air conditioner can't start cooling.

ECOAIR RECOMMENDS THAT INSTALLATION IS CARRIED OUT BY A QUALIFIED F-GAS ENGINEER

Install snow guard (Optional)

Consideration of snow during installation of outdoor units

Note:

- It may be required to equip a snow guard and a higher foundation base to prevent snow from covering the air inlet and outlet.

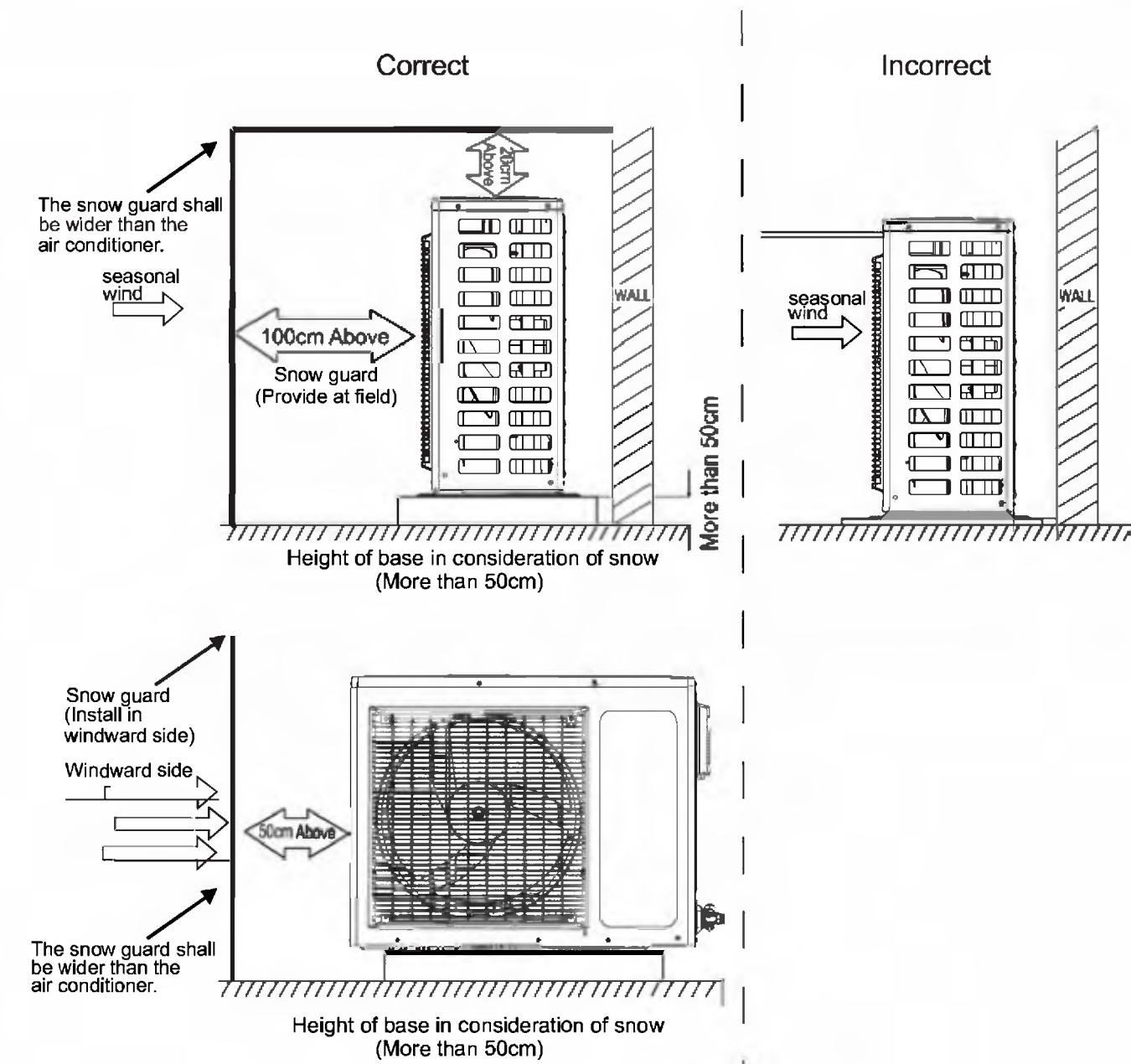

Configuration of connection pipe

1. Standard length of connection pipe : ▪ 4m.
2. Min. length of connection pipe is 3m.
3. Max. length of connection pipe and max. high difference.

Cooling capacity	Max length of connection pipe	Max height difference
9000Btu/h (2637W)	15	5
12000Btu/h (3516W)	20	10
18000Btu/h (5274W)	25	10
24000Btu/h (7032W)	25	10

4. The additional refrigerant oil and refrigerant charging required after prolonging connection pipe is:

- After the length of connection pipe is prolonged for 10m at the basis of standard length, you should add 5grams of refrigerant oil for each additional 5m of connection pipe.
- The calculation method of the additional refrigerant charging amount (on the basis of liquid pipe) is:
 - Additional refrigerant charging amount = prolonged length of liquid pipe × additional refrigerant charging amount per meter
- When the length of connection pipe is above 5m, add refrigerant according to the prolonged length of liquid pipe. The additional refrigerant charging amount per meter is different

Sheet 2. Additional refrigerant charging amount for R32

Diameter of connection pipe mm		Indoor unit throttle	Outdoor unit throttle	
Liquid pipe	Gas pipe	Cooling only, cooling and heating (g / m)	Cooling only (g / m)	Cooling and heating (g / m)
Φ6	Φ9.5 or Φ12	16	12	16
Φ6 or Φ9.5	Φ16 or Φ19	40	12	40
Φ12	Φ19 or Φ22.2	80	24	96
6	Φ25.4 or Φ31.8	136	48	96
Φ19	-	200	200	200
Φ22.2	-	280	280	280

Note: The additional refrigerant charging amount in Sheet 2 is recommended

Note:

Improper pipe expanding is the main cause of refrigerant leakage. Please expand the pipe according to the following steps:

1. Cut the pipe

- Confirm the pipe length according to the distance of the indoor and outdoor unit.
- Cut the required pipe with pipe cutter.

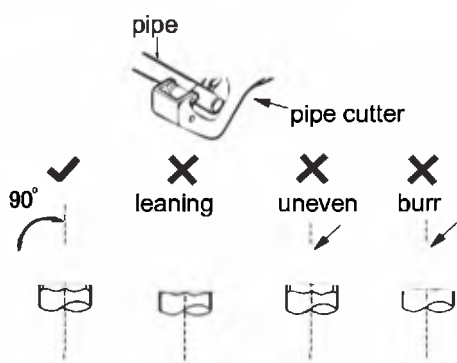

2. Remove the burrs

- Remove the burrs with the shaper and prevent the burrs from getting into the pipe.

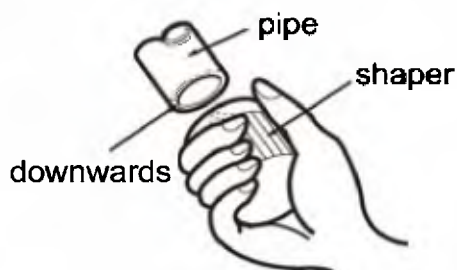

3. Put on a suitable insulating pipe

4. Put on the union nut

- Remove the union nut on the indoor connection pipe and outdoor valve; install the union nut on pipe.

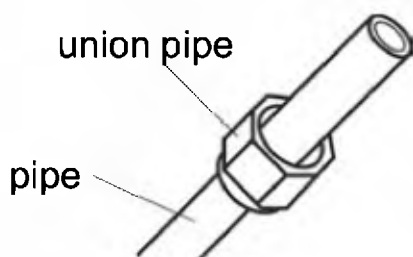

5. Expand the port

- Expand the port with an expander

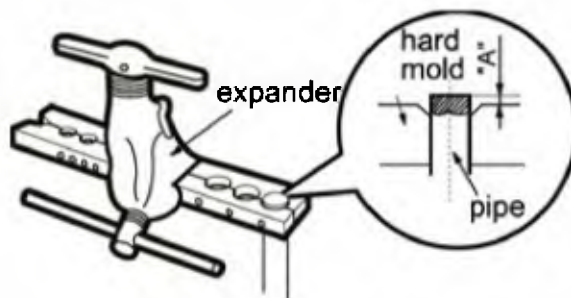

Note:

- "A" is different according to the diameter, please refer to the sheet below

Outer diameter (mm)	A (mm)	
	Max	Min
Φ6 - 6.35(1/4")	1.3	0.7
Φ9.52(3/8")	1.6	1.0
Φ12-12.7(1/2")	1.8	1.0
Φ15.8-16(5/8")	2.4	2.2

6. Inspection

- Check the quality of the expanding port. If there is any blemish, expand the port again according to the steps above

smooth surface

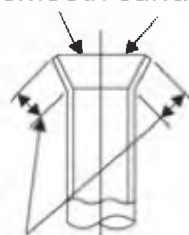

improper expanding

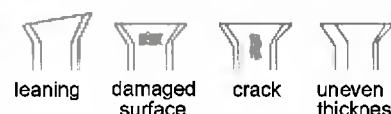

the length is equal

EcoAir guarantees this product to be free from defects in materials and workmanship for a period of One (1) year from the date of purchase. Coverage is valid only with proof of purchase.

Warranty Terms and Conditions

The conditions below apply to our warranty. They do not affect your statutory rights or the obligations of your retailer and your contract with them.

We provide warranty cover for this appliance subject to the following conditions:

1. We will rectify defects affecting the appliance which are clearly attributable to material and/or manufacturing faults, provided they are reported immediately after being identified within the Warranty Period supported by proof of purchase.
2. Service may not be available to all the islands around the UK. Please check with your retailer or contact our customer service department.
3. The warranty will not extend to consumables such as air filters.
4. Warranty liability will not be triggered by minor variances from nominal features which are of no significance to the appliance's value or fitness for purpose, nor damage caused by wear and tear, exceptional environmental conditions and inappropriate operating conditions.
5. No warranty liability will be accepted:-
 - a. If the defects stem from transport damage for which we are not responsible.
 - b. Improper installation and assembly or non-compliance with the safety regulations and warnings given in the operating instructions.
 - c. Improper use, to also include poor maintenance caused by insufficient aftercare or cleaning and failure to observe operating or assembly instructions or use with improper voltage recommendations.
 - d. Use in a non-domestic environment, to include air conditioner for rental.
 - e. If the installations has not been carried out by a qualified F-Gas Engineer.
6. No rights are given under this warranty to a person acquiring the appliance second hand.
7. We reserve the right to invalidate the warranty: -
 - a. If repairs or other interventions are performed by persons not authorised by us.
 - b. If our appliances are fitted with non-original spare parts, extras or accessories.
 - c. If our appliance has been altered and damaged by owner or third parties.
 - d. In the event of abuse (whether physical or verbal abuse) towards any member of staff.
8. Warranty provision will be free of charge and we will decide whether this will take the form of a repair or the replacement of the appliance. Small appliances that can be reasonably transported or posted may need to be handed over or shipped to our customer service centre. A purchase receipt must be presented in each case. Replaced parts pass into our ownership.
9. Under no circumstances shall the application of this warranty give rise to the complete replacement of the appliances. In the event of a replacement appliance being supplied at our discretion, we reserve the right to charge an appropriate monetary offset in respect of the period of use already enjoyed.
10. The provision of services under warranty neither extends the terms of the warranty nor sets in motion a new Warranty Period. The Warranty Period for spare parts fitted ends with the expiry of the warranty on the appliance as a whole.
11. EcoAir shall not be liable for loss of goods, loss of use, or any special, indirect, consequential or pure economic loss, costs, damages, charges or expenses. This does not apply for death or personal injury resulting from negligence on the part of EcoAir, or for any damage incurred as a result of fraud or fraudulent misrepresentation by EcoAir.
12. Our Warranty service only covers parts and not labour. It DOES NOT cover gas or gas leaks.
13. This unit is only for domestic use.
14. The Customer acknowledges and agrees that details of the Customer's name, address and payment method will be held and used by EcoAir to provide the services and to send to the Customer further Information. EcoAir may disclose your information to third parties and agents in order to perform the services.

These warranty conditions apply to appliances purchased in the United Kingdom. If appliances shipped to other countries feature the appropriate technical conditions (e.g. voltage, frequency, gas-types etc.) for the climatic and environmental conditions in the country concerned, the terms of the warranty will apply, provided a local customer service network exists. Appliances purchased outside the United Kingdom are subject to the warranty conditions published by the appropriate local representative office of that country. These can be obtained via the specialist dealer from whom you bought the appliance.

ecoair®



www.ecoair.org
C363 /C364

