



ARION 26L

POWERFUL ULTRA ENERGY EFFICIENT DEHUMIDIFIER



BS PLUG WIRING

Wiring Instructions: Should it be necessary to change the plug, please note the wires in the mains lead are coloured in accordance with the following codes:

BLUE - NEUTRAL
BROWN – LIVE
GREEN AND YELLOW - EARTH

In the event that the colours of the wires in the mains lead of this appliance does not correspond with the coloured markings identifying the terminals in your plug, proceed as follows:

1. The **BLUE** wire is **NEUTRAL** and must be connected to the terminal which is marked with the letter **N** or coloured **BLACK**.
2. The **BROWN** wire is **LIVE** and must be connected to the terminal which is marked with the letter **L** or coloured **RED**.
3. The **GREEN/YELLOW** is **EARTH** and must be connected to the terminal which is marked with the letter **E** or \oplus or coloured **GREEN** or **GREEN/YELLOW**.
4. Always ensure that the cord grip is positioned and fastened correctly.

If a **13A (BS 1363)** fused plug is used it must be fitted with a **13A** -fuse. If in doubt consult a qualified electrician.

Wiring for a 13 Amp Plug (BS1363)

Please note. The Earth Terminal is marked with the letter E or \oplus Earth Symbol.

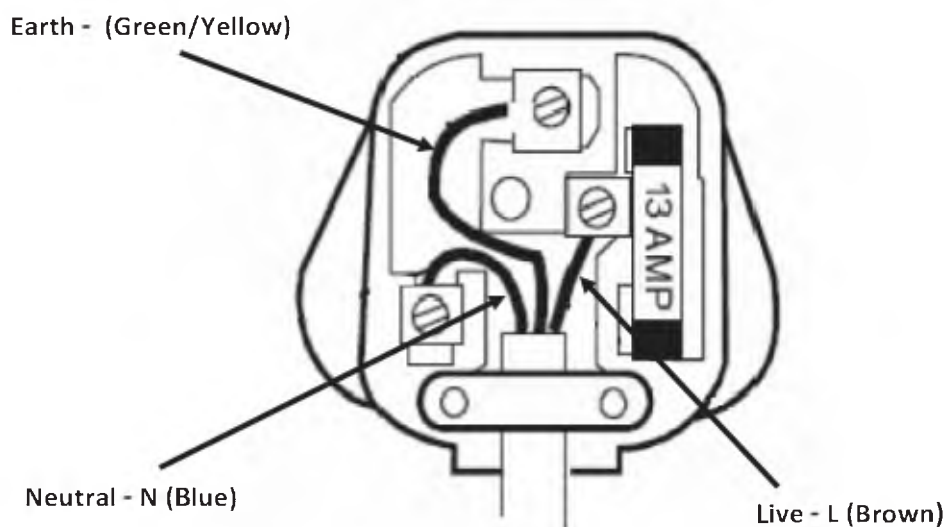

WELCOME

Thank you and congratulations for choosing an EcoAir dehumidifier to help you improve the air quality within your home. Inside you will find many helpful tips on how to use and maintain your dehumidifier efficiently. Just a little preventative care can save you money and prolong the life of your dehumidifier.

The purpose of the dehumidifier is to remove the excess moisture in the air by detecting the humidity level in the room. By keeping humidity within recommended levels, a dehumidifier combats household damp, mould and mildew. Dehumidifiers can help to reduce the symptoms of asthma, allergies, and other respiratory health conditions. They can also be used to help dry laundry quicker and control moisture-based damage (such as the aftermath of flooding, leaks or rising damp) to valuable belongings and furniture.

HUMIDITY GUIDE

There will always be water vapour in the air. The water vapour (or commonly known as moisture) in the air is measured in % Relative Humidity (RH). RH is the ratio of the actual amount of water vapour in the air to the amount it could hold when saturated expressed as a percentage. Too much or too little moisture in our homes can be unhealthy and uncomfortable. The optimum humidity level is between 40% and 60% (RH) where we feel most comfortable.

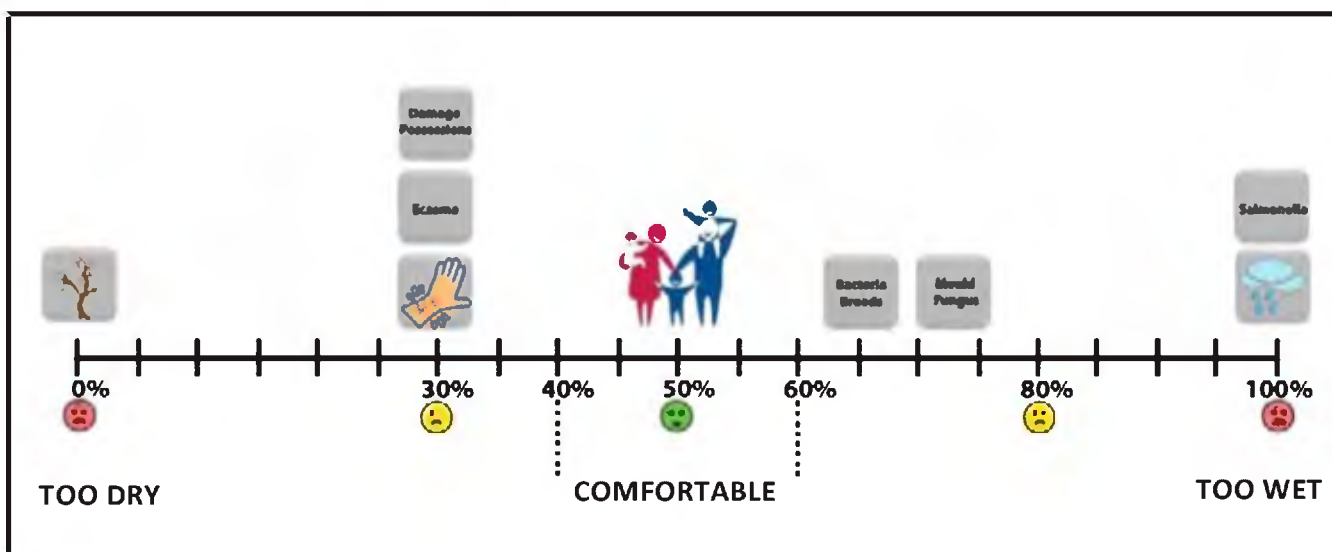

LOW HUMIDITY

Low humidity indoors causes excess drying which can trigger skin irritations such as eczema, chapped skin and dry nose. It can also damage possessions, such as wooden furniture, musical instruments and artwork by drying it out too much.

HIGH HUMIDITY

High humidity indoors causes damp and condensation. The damp left by condensation can damage plaster, wall paper, furniture, vehicles, timber windows, doors and clothes. It can be harmful to our health when bacteria thrives, causing mould and fungus.

MAINTAINING SAFE LEVELS OF HUMIDITY

It is important to maintain a consistent humidity range to preserve furniture, paintings, door and window frames. High humidity causes swelling, corrosion, softening of glues and paint. Low humidity causes shrinking, cracking, warping of wood surfaces and gaps in joints, doors and windows. Frequent changes in humidity levels can accelerate damages to property and belongings.

CONDENSATION

The warmer the air, the more moisture the air can hold than colder air. So, when the air inside the house becomes colder, the moisture contents in the air becomes saturated, and gets heavier resulting in moisture concentration on the coldest parts of the house particularly on the windows, bathroom mirrors and walls. This is condensation, caused by a sudden increase in humidity, cooking, showers, drying clothes, inadequate ventilation and poor thermal insulation.

Condensation does not disappear instantly even with the dehumidifier on. Where excessive condensation appears for example, on your windows, you may want to open your windows to expel the excess humidity for several minutes. It will take a while for the condensation to generally increase the humidity in the room. Once the humidity level in the room around the dehumidifier is increased above the level you have set on the dehumidifier, it will then begin the dehumidification process.

KEY FEATURES

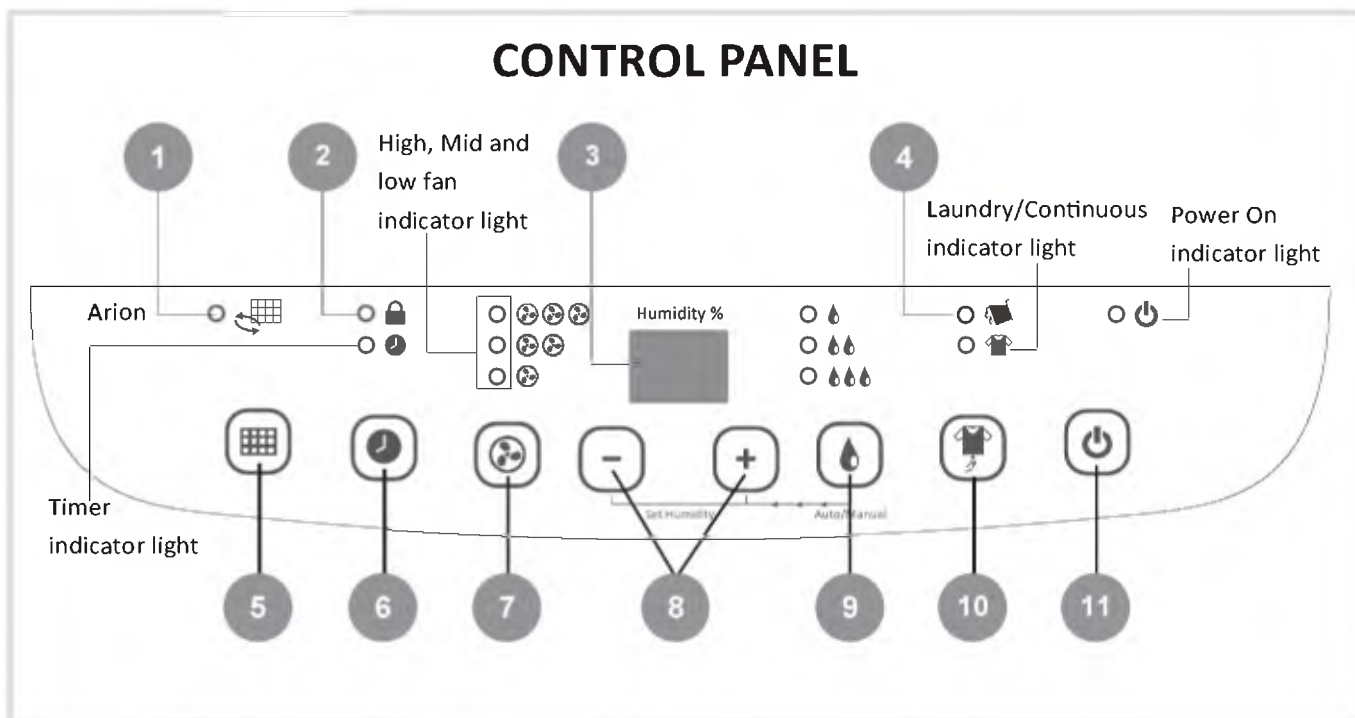

1. **Filter Clean Indicator** - icon Indicates that the air filter needs cleaning or replacement. Cleaning your filter regularly helps to prolong the life of the dehumidifier and gives you cleaner air.
2. **Lock Function** - Press and hold both button simultaneously for 3 seconds (LC) will display on the panel. To unlock, follow the same procedure.
3. **Humidity Display Panel** - Displays actual humidity level (%RH) in the room while the dehumidifier is running and your set target humidity level (%RH) when selecting the desired humidity using the or buttons.
4. **Water Full Light Indicator** - Lights up when Water Tank is full, missing or is inserted incorrectly.
5. **Filter Clean Reset Button** - Once the filter has been cleaned and replaced, press the filter clean reset button to reset the filter clean indicator.
6. **Timer Button** - Select to set timer ON or OFF.
7. **Fan Speed** - Select for High, Select for Medium or for Low fan speed.
8. **Set Humidity Button** - Press or to increase and decrease your humidity target settings. The humidity ranges from 35%RH to 80%RH. To access this mode, you have to be in Manual mode. (Please see page 5 step 6)
9. **Auto/Manual Button** - Select for access pre-set humidity settings and to switch off auto settings (until the light goes off)
10. **Laundry/Continuous Button** - Select to turn on laundry mode. A green Laundry LED indicator stays on when in Laundry mode. In Laundry mode, the dehumidifier will run continuously.
11. **Power Key** - Turn dehumidifier on ON/OFF.

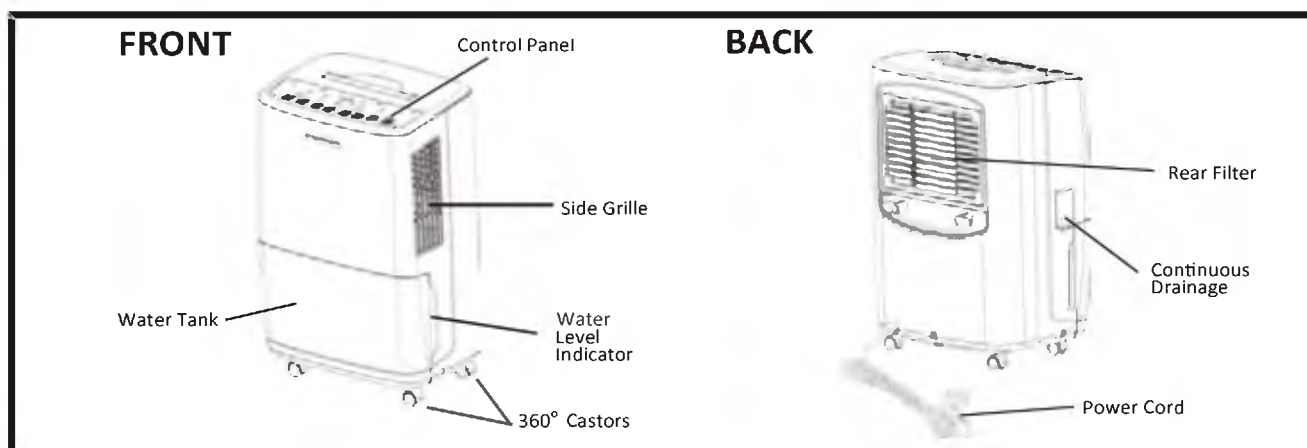

QUICK START UP

STEP 1 - WHERE TO POSITION YOUR DEHUMIDIFIER?

After unpacking your dehumidifier, place it upright to allow the compressor to stabilise for at least 4 hours before use.

Ensure the dehumidifier is a safe distance away from a wall or furniture, away from direct sunlight.

TIP: Position the dehumidifier in the dampest room or somewhere central like a landing or a hallway. As long as the internal doors are open the excess moisture from all of the rooms in the house will migrate naturally towards the dehumidifier and be processed.

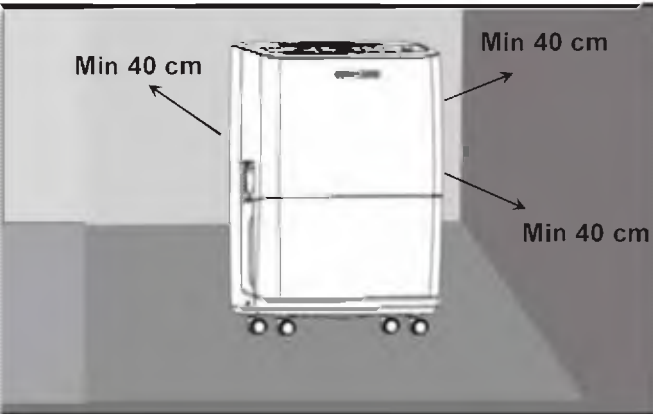

STEP 2 - CAUTION - AVOID USING IN



- Areas where ambient temperature falls below 5°C.
- Small confined area i.e. broom cupboard, boiler room, unventilated rooms etc.
- Close proximity to a heat source such as heater, tumble dryer, cooker.
- Dusty or building sites or an industrial environment where particles can clog up the filter or internal components. This will cause the dehumidifier to malfunction, voiding your guarantee.



STEP 3 - ON/OFF



TO
OPERATE
ARION

- Always place the dehumidifier in an upright position on an even level surface.
- Plug the dehumidifier into the mains socket, power on indicator will remain on whilst the dehumidifier is plugged in to the mains.
- The dehumidifier performs best at a minimum ambient temperature of 15°C. Where ambient temperature is below 15°C it will need to go into defrost mode periodically to preserve the life of the compressor.
- Press the ON/OFF button to operate the dehumidifier.
- Now select Mode. (See step 4)

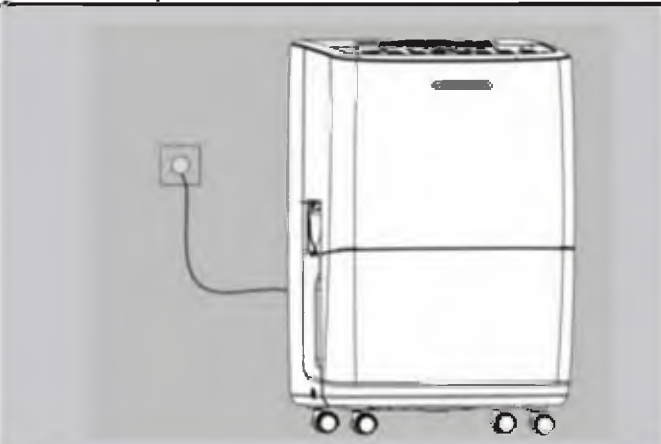

STEP 4 - FAN MODE



Low



Select for low fan speed

- Use for quiet operation or when humidity has been reduced.
- Highly recommended for night use.

Medium



Select for medium fan speed

- Use to combat excessive humidity in day time operation.
- Highly recommended for day use.

High

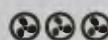









Select for high fan speed

- Use for maximum moisture removal.
- Highly recommended for drying laundry or problem areas.



Tip:





When turning on the dehumidifier, if your desired humidity setting is higher than the actual humidity, the dehumidifier will run on fan-only mode to sample the air for 5-10 minutes, to sense the ambient humidity before switching off automatically.







QUICK START UP



STEP 5 - TIMER 	
	This is a ON or OFF timer Only
SETTING TIMER OFF	
<ul style="list-style-type: none"> The unit has to be on. Press Timer Button  LED light will blink then press  or  button to increase or decrease time, the display window will show the duration. When time is set, wait 5 sec LED will stop flashing and the timer light stays ON. 	
SETTING TIMER ON	
<ul style="list-style-type: none"> The unit must be off but Power on. Press time button  LED light will blink then press  or  button to increase or decrease time, the display window will show the duration. When time is set, wait 5 sec LED will stop flashing and the timer light stays off. 	
<p>Note: Wait 3 minutes before resuming operation. After the dehumidifier has stopped (other than tank full) it will not restart for approximately 3 minutes. This is to protect the dehumidifier and is not a fault. Operation will automatically restart after 3 minutes.</p>	

STEP 7 - LAUNDRY/CONTINUOUS (CONTINUED FROM STEP 6)	
	<ul style="list-style-type: none"> Press until the Laundry/Continuous indicator light turn on. Select desired fan speed. The dehumidifier will operate continuously at its maximum dehumidification settings until setting is changed or the water tank is full.
<p>Note: If connected to a hose pipe for continuous drainage the dehumidifier will continue run on its maximum dehumidification settings.</p>	

STEP 9 - TANK FULL INDICATOR 	
	<ul style="list-style-type: none"> Indicator lights up when water tank is full or incorrectly inserted. The dehumidifier will automatically switch off. Remove water tank, empty and reinstate correctly.
<p>Note:</p> <ul style="list-style-type: none"> If the tank is full or removed for more than a 3 minute period, an alarm will sound for about 10 seconds to alert the water tank needs emptying or placing back into position. When the water tank is full or removed, the controls are disabled. 	

STEP 6 - HUMIDITY BUTTON (MANUAL MODE)	
	<p>Select for higher desired humidity.</p> <ul style="list-style-type: none"> Press to set to a higher % value up to 80% RH.
	<p>Select to reduce the humidity levels.</p> <ul style="list-style-type: none"> Press to select a lower % down to 35% RH.
<p>Note : The humidity   button can only be use when all water drop and laundry lights are off. To change setting, press the mode  button.</p>	
<p>The display will show the actual humidity in the room 5 second after the humidity level is set on the control.</p>	
<p>The humidity level can be set within a range of 35% RH to 80% RH at 5% intervals.</p>	
<p>To adjust the RH% use + or - keys, either side of the electronic display.</p>	

STEP 8 - MODE FUNCTION 	
<p>Select  to excess pre-set humidity settings</p>	
	<ul style="list-style-type: none"> 55% with low fan speed (economy)
	<ul style="list-style-type: none"> 50% with medium fan speed
	<ul style="list-style-type: none"> 45% with high fan speed
	<ul style="list-style-type: none"> 35% with high fan speed
<p>Note: When in pre-set humidity mode, fan speed can still be adjusted by pressing the  button</p>	

STEP 10 - FILTER 	
	<ul style="list-style-type: none"> The filter clean indicator will light up when the filter needs cleaning. Once the filter has been cleaned and replaced into position, press  button to reset the filter clean indicator. To purchase a replacement filter please visit:
<p>www.ecoairdirect.com</p>	

MAINTENANCE

STEP 1 - CLEANING YOUR FILTER

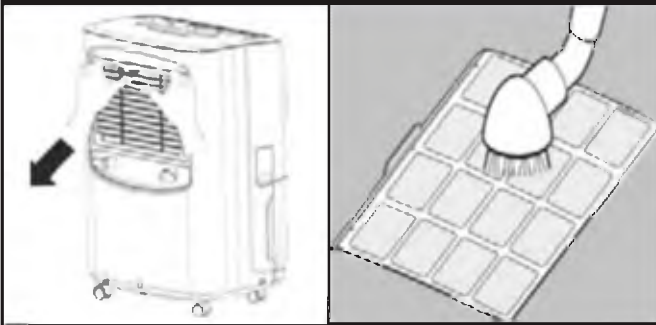

1. Turn OFF the dehumidifier and remove the filter from the unit by pulling the filter out.
2. Clean the filter lightly with a brush or vacuum cleaner or warm mild soapy water. Allow the filter to air dry fully.
3. Replace the filter back into position. Press the  Filter key to reset.
4. If the filter is covered with dust, the airflow and the performance of the dehumidifier will be affected. Check the filter periodically to ensure all dust is removed.

Tip: Clean your filter every 2 weeks to keep your air clean and prolong the life of your dehumidifier. The frequency will depend on conditions of operation.

STEP 2 - REPLACING YOUR FILTER

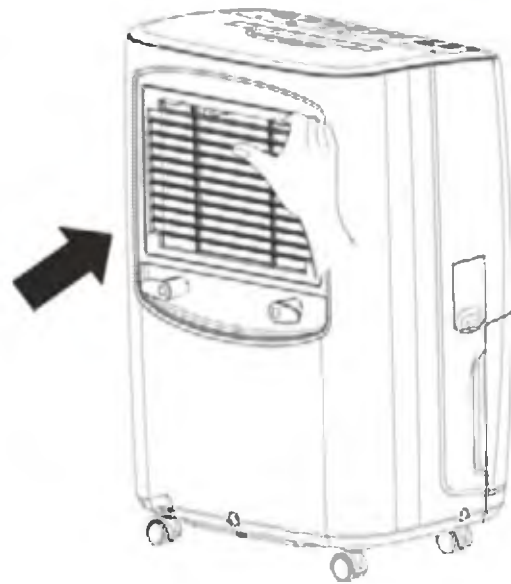

It is recommended that the filter is replaced every year for optimal performance and hygiene standards. To purchase a replacement filter please visit:

www.ecoairdirect.com

STEP 3- CLEANING YOUR DEHUMIDIFIER

1. Turn the dehumidifier OFF, wait for the fan to stop and unplug the dehumidifier from the socket.



2. Clean the surface with a soft damp cloth.
3. Dry thoroughly with a towel after cleaning.
4. Empty the water tank. Allow water tank to drip dry or dry with a cloth.

Caution:

- Do not wash the dehumidifier or immerse in water.
- Do not let water drip into the air inlet or outlet.

STEP 4 - STORING YOUR DEHUMIDIFIER

1. Turn OFF the dehumidifier, wait for the fan to stop and unplug the dehumidifier from the power socket.
2. Leave the dehumidifier to drain for approximately one day. Clean and dry the water tank.
3. Clean the filter and the dehumidifier. Cover the dehumidifier to prevent it from gathering dust. Store upright in a cool dry place.
4. Do not expose to direct sunlight.

EMPTYING THE WATER TANK

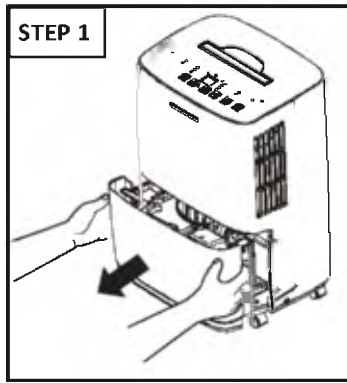

Slide water tank out

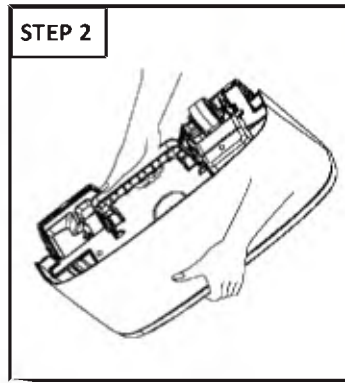

Hold the handle and
pour the water out

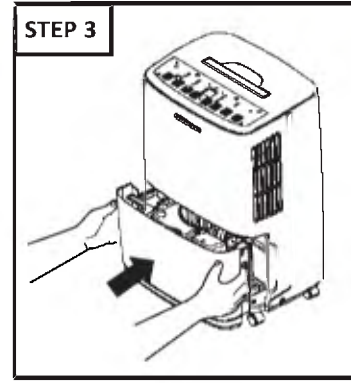

Slide water tank in

1. The Water Full Indicator lights up when the water tank is full and the dehumidifier stops operating.
2. Do not move the dehumidifier or remove the water tank when the dehumidifier is running, as water may leak; causing damages to the dehumidifier or an electric shock.
3. Before removing the water tank leave the dehumidifier to stand for approximately 10 minutes to ensure all water has dripped into the water tank.
4. To remove the water tank, slide it out gently by gripping the water tank from both sides and lift carefully.
5. Pour the water away by tilting the water tank from the purpose-made outlet, (see step 2 picture) to the left side. Clean the water tank.
6. Reinsert the water tank to the correct position, as soon as possible to prevent water dripping from the dehumidifier.

NOTE :

- Clean the water tank with clean water if needed. Do not use detergent, solvent, abrasive or hot water to avoid damaging the water tank or float.
- Do not remove or damage the float in the water tank or the dehumidifier will not operate properly.
- The Water Full light indicator illuminates if the water tank is not correctly in position.
- Do not tilt the dehumidifier when removing the water tank.
- If the water tank is removed whilst the dehumidifier is running the fan will continue to run for 3 minutes.

CONTINUOUS DRAINAGE

1. Remove water tank from the dehumidifier and open the drainage cover from the side of the unit. Install the drainage connector by screwing it clockwise onto the drainage outlet tightly.

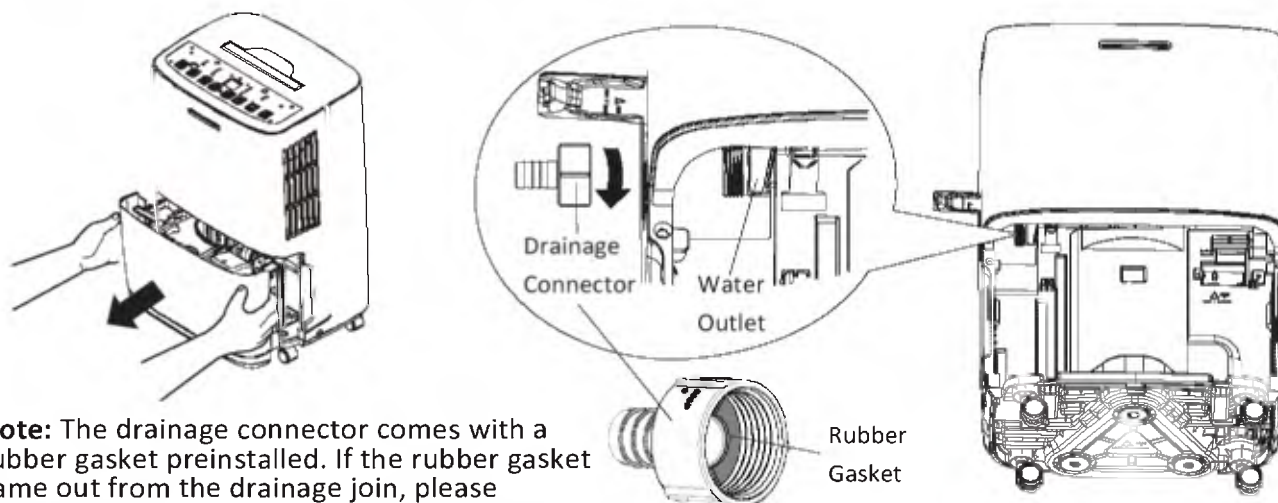

Note: The drainage connector comes with a rubber gasket preinstalled. If the rubber gasket came out from the drainage joint, please ensure the rubber gasket is installed back in place to prevent water leakage.

2. Insert the drain hose into the drainage connector and reinsert the water tank back into the dehumidifier.

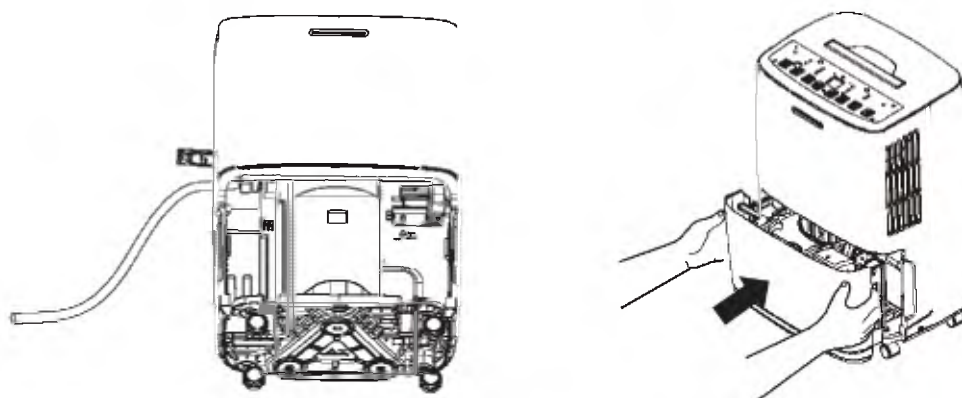

3. Run the drain hose downwards. The drain hose can not be above the drainage joint. This will cause flooding of your dehumidifier. Make sure the drain hose is not pressed in any way.

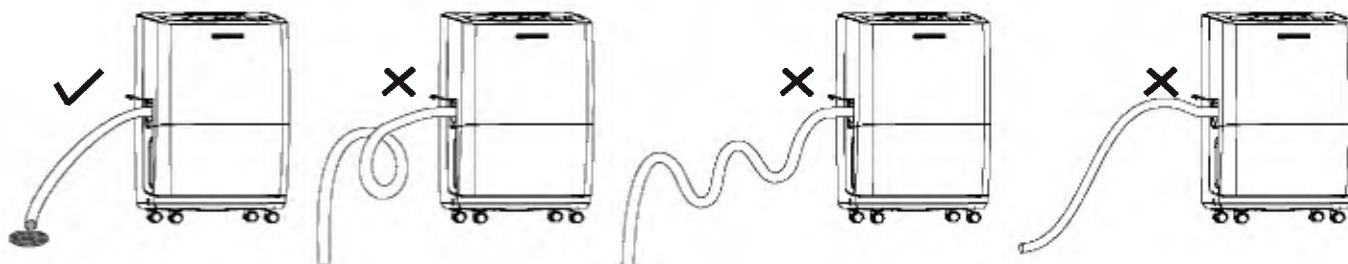

4. When removing the drain hose, prepare a container to collect water from nozzle.

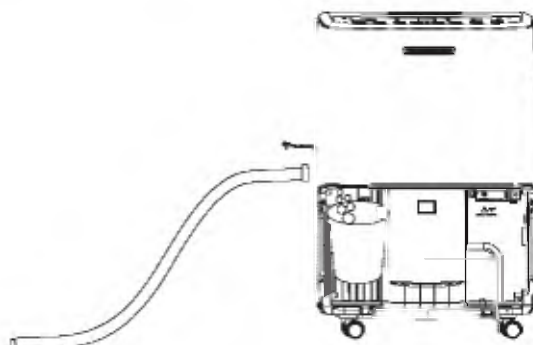

CASTER INSTALLATION

1. Remove the water tank, slide it out gently by gripping the water tank from both sides and lift carefully.
2. Take out accessory box (There are 4 castors)
3. Reinsert the water tank to the correct position

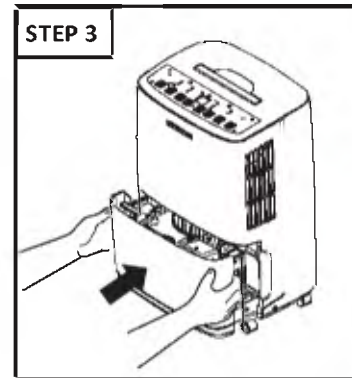
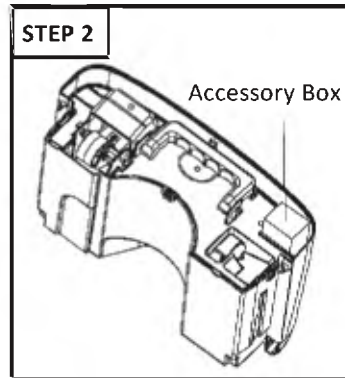
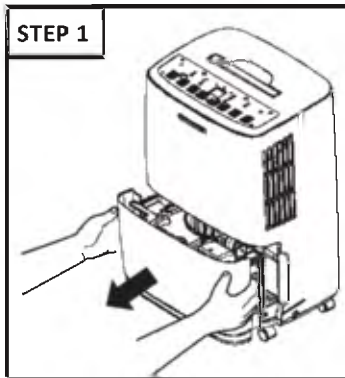

4. Take the casters out from the accessory box.
5. Tilt the dehumidifier not more than 45°. Align the caster shaft into the caster installation hole below the dehumidifier and push the castor upward till it fits properly.

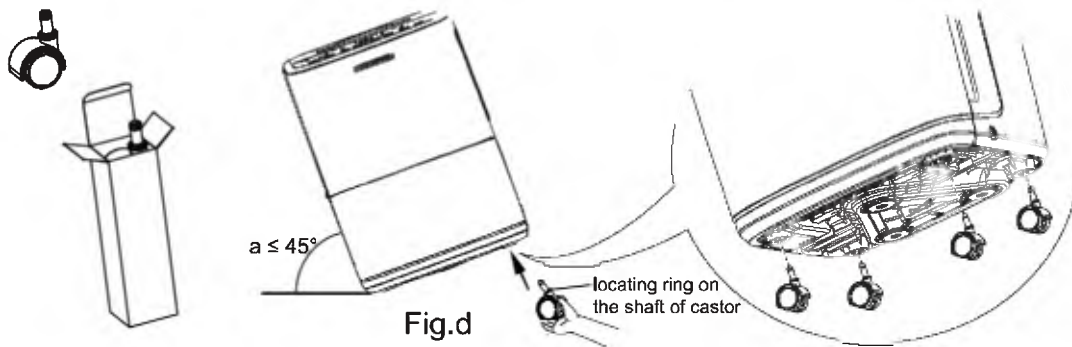

6. Repeat the same process as Step 5 for other 3 casters

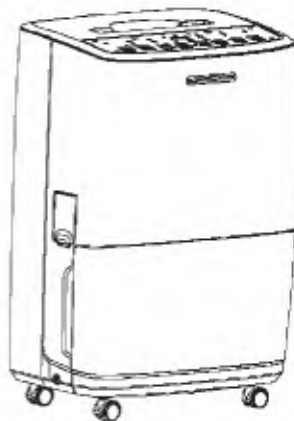

NOTE:

- Keep the dehumidifier balance during installation to prevent the unit from falling.
- 4 casters must be installed well before operating the dehumidifier.

IMPORTANT SAFETY INSTRUCTIONS

PLEASE READ ALL INSTRUCTIONS CAREFULLY BEFORE OPERATING.

WARNING! This dehumidifier is intended for domestic and light office use only. Any other use is not recommended by the manufacturer and may cause fire, electrical shocks or other injuries to person or property.

When using electrical appliances, basic safety precautions should always be followed:

1. Do not operate the dehumidifier where there is a damaged cord or plug or after it malfunctions or it has been dropped or damaged in any way. Arrange for the dehumidifier to be examined or repaired by an authorised technician.
2. Always keep the dehumidifier in an upright position to avoid any damage. Place the dehumidifier on an even level surface during operation.
3. Ensure the household voltage matches the rated specification for the dehumidifier before use.
4. Operate this dehumidifier in an ambient temperature between 5°C and 35°C.
5. Ensure that the air inlets and outlets are not blocked or covered. Do not insert fingers or any objects into the air inlet or outlet openings.
6. Do not place the dehumidifier too close to curtains or other objects, keep minimum distance of 40cm.
7. When using the "LAUNDRY" mode to dry wet clothes efficiently, keep the laundry at a safe distance from the dehumidifier to prevent water from dripping onto the dehumidifier.
8. Never place anything on top of the dehumidifier and do not cover while in use or before it cools down.
9. To protect against electrical shocks, do not immerse or spray the dehumidifier or any of its parts in water.
10. Never unplug the power cord without switching OFF the dehumidifier first.
11. Always unplug the dehumidifier when not in use or when moving location. To disconnect the dehumidifier from the power supply, grip the plug and pull from the power socket. Never pull by the cord.
12. Always empty the water tank before storing the dehumidifier away.
13. Close supervision is necessary when the dehumidifier is used in the presence of children and pets.
14. Do not run power cord under carpeting, or cover with rugs or runners. Arrange the cord away from areas where it may become a tripping hazard.
15. Never operate or store the dehumidifier in direct sunlight.
16. Repairs must be carried out by an authorised technician, failure to do so may cause damage to the dehumidifier or injury to persons or property and void the warranty. Always insist on original spare parts.
17. Avoid the using of an extension cable as they may overheat and cause a risk of fire.
18. Do not use the dehumidifier without the air filter. Clean or replace the air filter regularly.
19. Dispose of the water collected from the dehumidifier, this water is not drinkable.
20. Do not leave the dehumidifier unattended in continuous drainage over a long period of time.
21. At the end of its working life dispose the dehumidifier responsibly, in accordance with local by laws.
22. Do not remove the water tank when running, this may cause water to leak.
23. Do not lead the end of continuous drainage hose outside when temperature is below 1°C.
24. Do not use any heating application near the dehumidifier.
25. Do not remove the power plug in wet hands.
26. Damaged power cord must be replaced by qualified technicians or manufacturer.

This dehumidifier is not intended for use by persons (including children) with reduced physical, sensory or mental capabilities, unless they have been given supervision or instruction concerning use of the dehumidifier by a person responsible for their safety. Children should be supervised to ensure that they do not play with the dehumidifier.

READ & SAVE THESE IMPORTANT SAFETY INSTRUCTIONS FOR FUTURE REFERENCE

TROUBLESHOOTING

INITIAL CHECKS BEFORE CONTACTING TECHNICAL SUPPORT.

PROBLEM	REASON	SOLUTION
No Power	Dehumidifier is not plugged in or there is no power supply	Plug the dehumidifier into mains and switch plug ON. Check the main power supply
	Dehumidifier has reached its pre-set level or tank is full.	The dehumidifier automatically turns off when either condition occurs. Change to a lower humidity setting or empty the tank and replace properly.
	Water tank is not in the proper position.	The water tank must be in place and securely seated for the dehumidifier to operate.
	Power failure/Controls cannot be set	There is a protective time delay to protect the compressor. For this reason, the dehumidifier may not start normal dehumidifying for 3 minutes after it is turned back on.
Filter Check Light On	Filter clogged	Check and clean or replace the filter
	The air inlet or outlet is blocked or covered	Remove obstructions
Water Full Light On	Water tank is full or installed incorrectly	Empty water tank or re-install correctly
	Water float out of position	Restore water float back into position
	Dehumidifier on uneven surface or water tank fitted incorrectly	Ensure the dehumidifier is on a flat, even surface, use a spirit level to check, remove tank and replace correctly
Water Leaking	Damaged water tank	Remove the water tank, fill with water and place on a hard even surface to test for leaking.
	The continuous drainage is clogged or loose Dehumidifier operating in colder environment	Check the continuous drainage hose and its connection Ensure room is within operating temperatures
Not Collecting Water	Did not allow enough time to remove moisture	When first installed, allowed at least 24 hours to maintain the desired dryness
	Set humidity is reached	Readjust the humidity settings
	Room is very cold or very dry for the current settings	Readjust the humidity setting or increase the room temperature Check room temperature and humidity levels
	Filter dusty	Clean the air filter or replace it
	Room Temperature is too hot	Open the window or door to ventilate
	Room Temperature is too cold	Increase heat in the room
Noisy	Water tank or filter fitted incorrectly Dehumidifier on uneven surface	Check and refit the water tank or filter Check dehumidifier is on an even level surface
	There is sound created when wind passing the dehumidifier.	This is normal
Frost Appears on Coils	Dehumidifier has been recently turned on, or room temperature is below 5°C	This is normal. Frost will usually disappear within 60 minutes. Do not operate the dehumidifier in temperatures below 5°C
Dehumidifier Run Too Much	Area to be dehumidified is too large	The capacity of your dehumidifier may not be adequate.

In the unlikely event of a problem with your product, please refer in the first instance to:
ECOAIR TECHNICAL SUPPORT
www.ecoair.org/support

SPECIFICATIONS

MODEL	ARION 26L
Operating Temperature Range	5°C ~ 35°C
Extraction Rate at 26.7°C, 60%RH	13.97 Litres per day
Extraction Rate at 30°C, 80%RH	26 Litres per day
Water Tank Capacity	4.2 Litres
Power Supply	220 - 240V~50Hz
Power Input	257W
Refrigerant	R134a
Net Weight	15 Kg
Gross Weight	17 Kg
Net Dimension (W x H x D)	351mm x 492mm x 260mm
Gross Dimension (W x H x D)	407mm x 530mm x 329mm

GUARANTEECARD

TWO (2) YEAR LIMITED GUARANTEE

SAVE THIS GUARANTEE INFORMATION

EcoAir guarantees this product free from defects in materials and workmanship for a period of Two (2) years from the date of purchase. Coverage is valid only with proof of purchase.

Exclusions: This guarantee does not cover:-

- Products used in the conditions other than the settings recommended and at the voltage indicated.
- Products used in a commercial setting or dusty environment.
- Service which do not involve malfunction or defects in materials or workmanship or those used other than in accordance with provided instructions.
- Appliance acquired second hand.
- Surcharges including, but not limited to, any after hour, weekend or holiday service calls and delivery charges.
- Damages caused by services performed by unauthorised service companies or use of parts other than genuine EcoAir parts or external causes; such as abuse, incorrect power supply, accidents, fires or acts of God.
- Replacement accessories such as filters.

This guarantee is in addition to, and does not affect, your Statutory Rights.

We recommend that you note the details of your purchase below and retain your original proof of purchase receipt with this user guide. Keep these documents safe in the event of a guarantee claim.

Date of purchase:

Retailer Name:

Serial number:

This limited guarantee only applies in the United Kingdom. Where the product has been taken from the country it was purchased to another country, the guarantee may be invalidated. However, we will always do our best to assist you in your new country of residence. EcoAir authorises no person to change or add to any obligations under this guarantee. Obligations for service and parts under this guarantee must be performed by EcoAir or an authorised service company. Product features or specification described may be subject to change without notice.



www.ecoair.org



C340



C340



66129926723