

---

# ESSENTIAL

---

## DEHUMIDIFIER

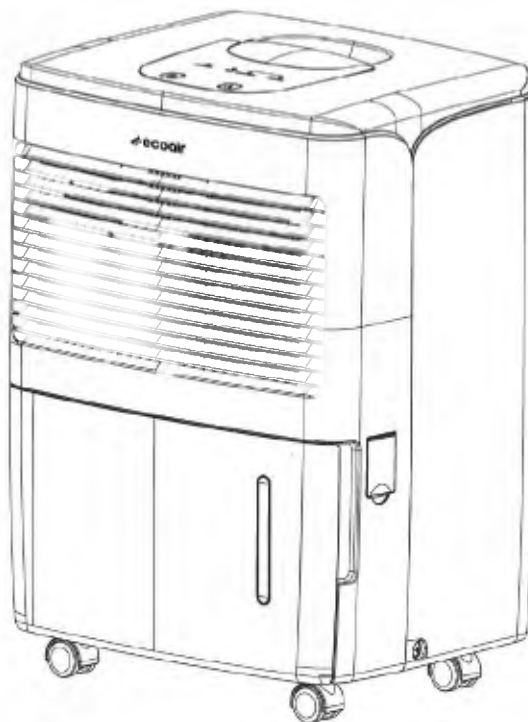

FOR MORE LANGUAGES, PLEASE VISIT:

[www.ecoair.org/userguide](http://www.ecoair.org/userguide)

# WELCOME

Thank you and congratulations for choosing an EcoAir dehumidifier to help you improve the air quality within your home. Inside this manual you will find many helpful tips on how to use and maintain your dehumidifier efficiently. Just a little preventative care can save you money and prolong the life of your dehumidifier.

The purpose of the dehumidifier is to remove the excess moisture in the air by detecting the humidity level in the room. By keeping humidity within recommended levels, a dehumidifier combats household damp, mould and mildew. Dehumidifiers can help to reduce the symptoms of asthma, allergies, and other respiratory health conditions. They can also be used to help dry laundry quicker and control moisture-based damage (such as the aftermath of flooding, leaks or rising damp) to valuable belongings and furniture.

## HUMIDITY GUIDE

There will always be water vapour in the air. The water vapour (or commonly known as moisture) in the air is measured in % Relative Humidity (RH). RH is the ratio of the actual amount of water vapour in the air to the amount it could hold when saturated expressed as a percentage. Too much or too little moisture in our homes can be unhealthy and uncomfortable. The optimum humidity level is between 40% and 60% (RH) where we feel most comfortable.

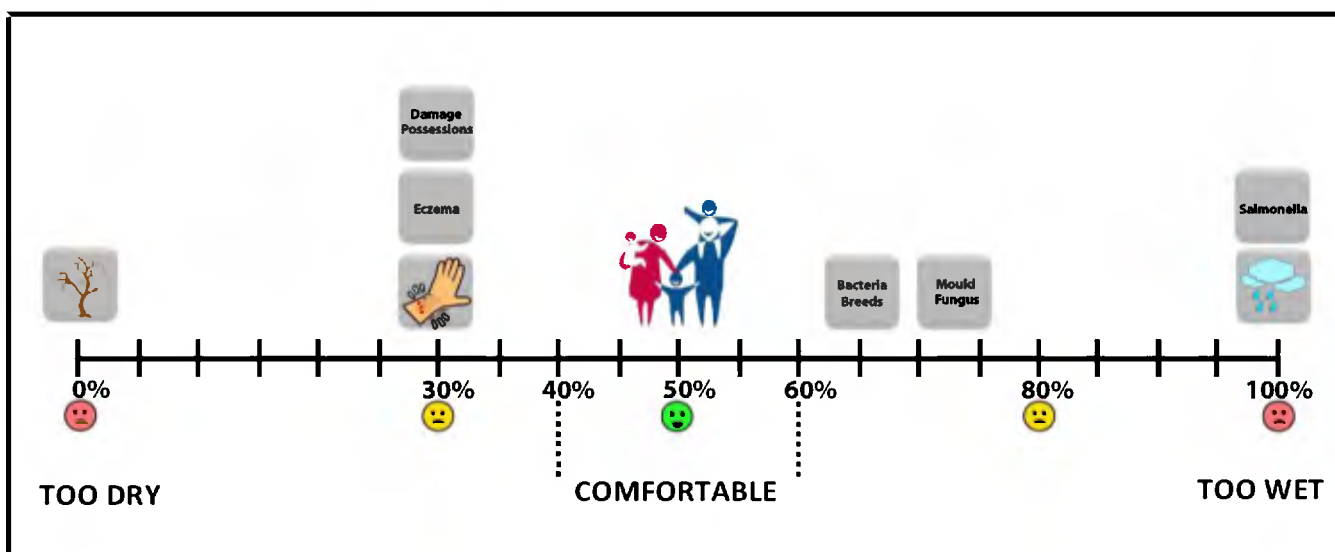

## LOW HUMIDITY

Low humidity indoors causes excess drying which can trigger skin irritations such as eczema, chapped skin and dry nose. It can also damage possessions, such as wooden furniture, musical instruments and artwork by drying it out too much.

## HIGH HUMIDITY

High humidity indoors causes damp and condensation. The damp left by condensation can damage plaster, wall paper, furniture, vehicles, timber windows, doors and clothes. It can be harmful to our health when bacteria thrives, causing mould and fungus.

## MAINTAINING SAFE LEVELS OF HUMIDITY

It is important to maintain a consistent humidity range to preserve furniture, paintings, door and window frames. High humidity causes swelling, corrosion, softening of glues and paint. Low humidity causes shrinking, cracking, warping of wood surfaces and gaps in joints, doors and windows. Frequent changes in humidity levels can accelerate damages to property and belongings.





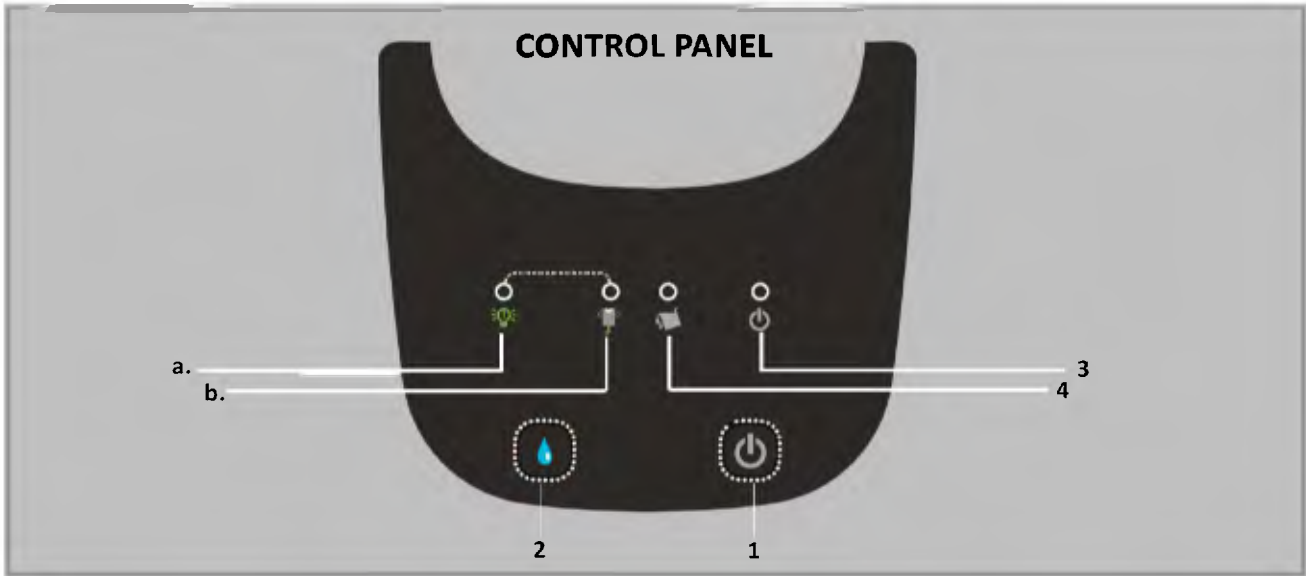

## CONDENSATION

The warmer the air, the more moisture the air can hold than colder air. So, when the air inside the house becomes colder, the moisture contents in the air becomes saturated, and gets heavier resulting in moisture concentration on the coldest parts of the house particularly on the windows, bathroom mirrors and walls. This is condensation, caused by a sudden increase in humidity, cooking, showers, drying clothes, inadequate ventilation and poor thermal insulation.

Condensation does not disappear instantly even with the dehumidifier on. Where excessive condensation appears for example, on your windows, you may want to open your windows to expel the excess humidity for several minutes. It will take a while for the condensation to generally increase the humidity in the room. Once the humidity level in the room around the dehumidifier is increased above the level you have set on the dehumidifier, it will then begin the dehumidification process.

# KEY FEATURES



1. **Power Key** - Turn unit on **ON/OFF**.
2. **Dry Mode Key** - Select:
  - a. **Smart Mode**  - Press  once. The dehumidifier will operate until it reaches a relative humidity between 45%RH - 55%RH
  - b. **CONTINUOUS LAUNDRY MODE**  - Press  twice. The dehumidifier will run continuously. It will rest every 36 hours for 15 minutes to preserve the compressor and save energy.
3. **Power On Indicator Light**  - The light will turn on when dehumidifier is on and off when on standby mode.
4. **Water Full Light Indicator**  - Lights up when Water Tank is full, missing or is inserted incorrectly.

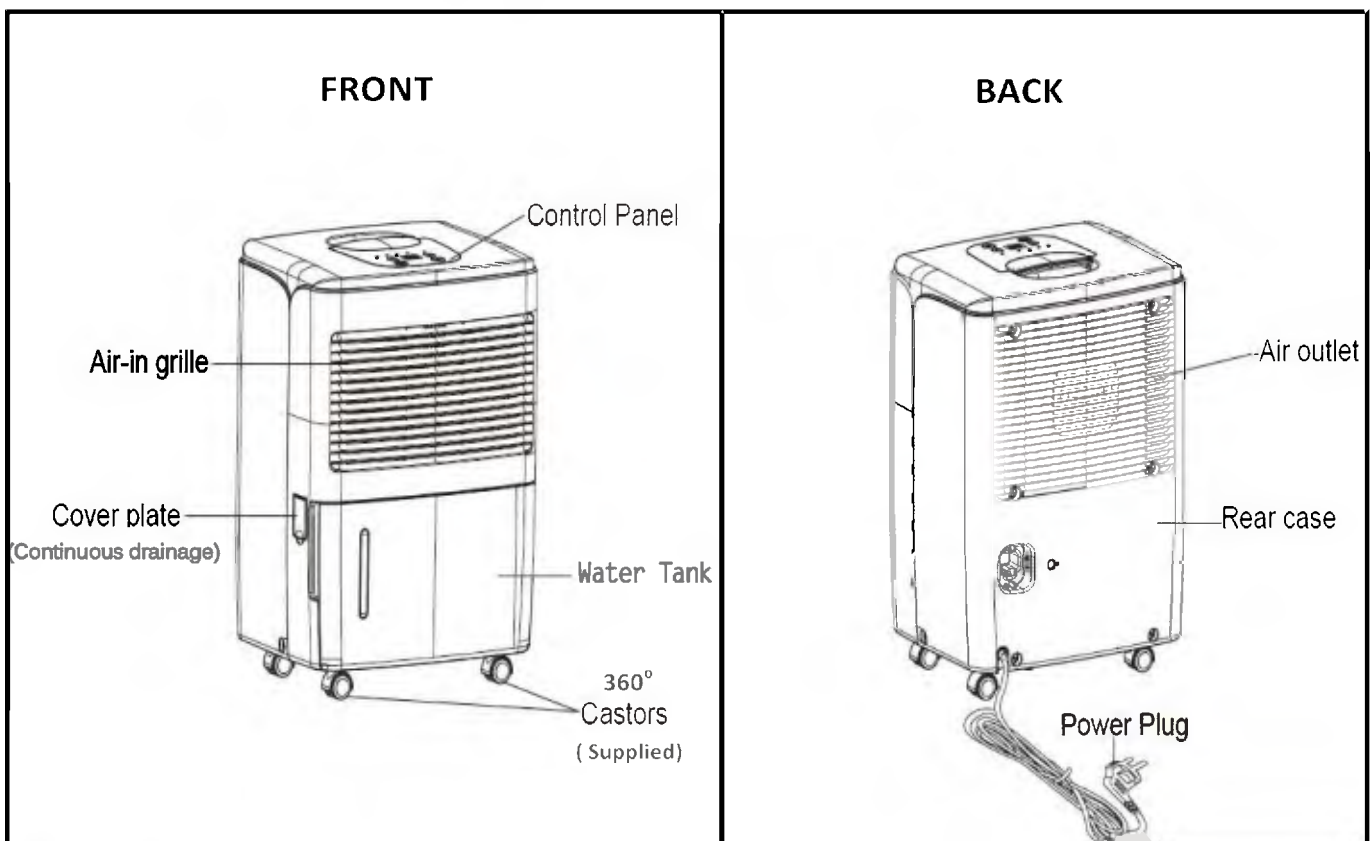

# QUICK SET UP

## CASTOR WHEEL INSTALLATION

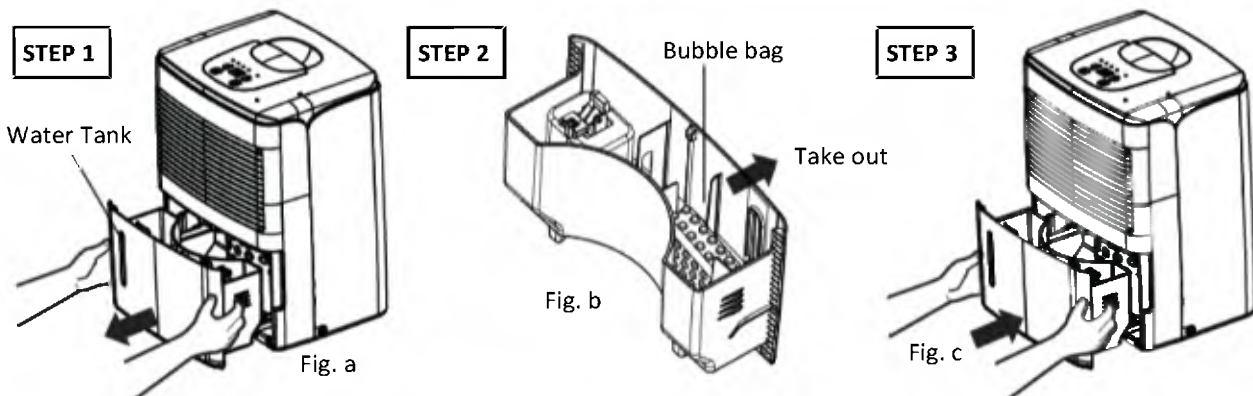

1. Hold the grip on the both sides of the water tank and gently remove the water tank. (As shown in fig.a)
2. Remove bubble bag from inside the water tank. (there are 4 castors and 1 cable tie as shown in fig.b)
3. Insert the water tank to its original position. (As shown in fig.c)
4. Remove 4 castors and 1 cable tie from bubble bag.

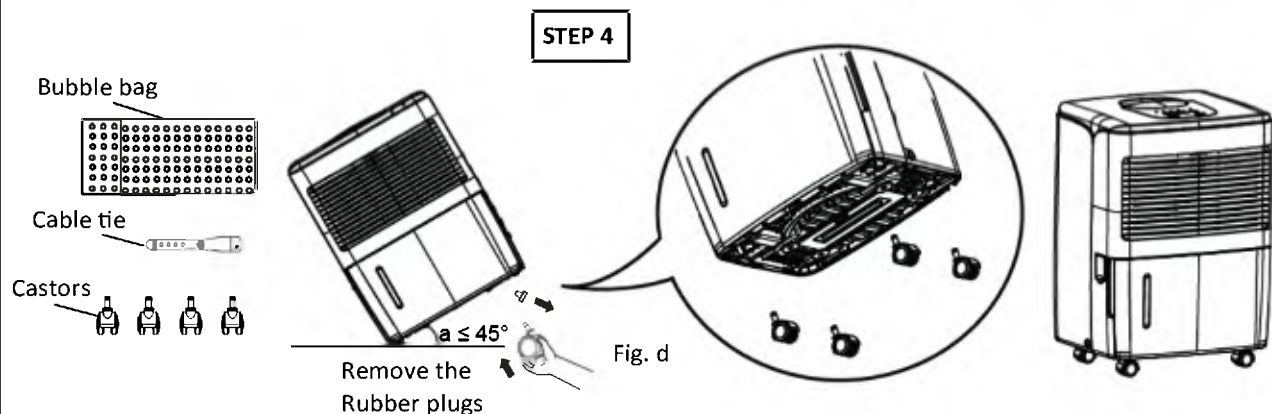

5. Tilt the dehumidifier at no more than  $45^\circ$ . Remove the four rubber feet from underneath of the unit. Aim the shaft of castor at the installation hole on chassis, and then push the castor into it. Repeat the same for the 3 other castors, then leave the unit on the up right position on the floor. (As shown in fig.d)

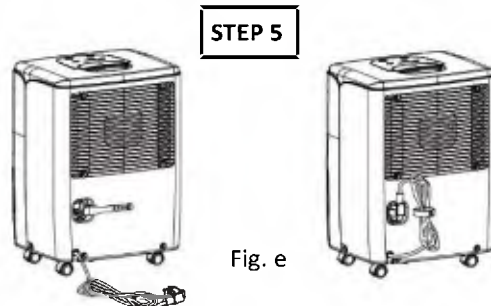

6. To tidy the power cable at the rear, use the cable tie provided with the dehumidifier. Put the power plug into the clamp. (As shown in fig.e)

### NOTE:

1. It is advisable that during castors installation the dehumidifier should be held by another person
2. Four castors must be installed correctly before operating the unit.
3. Remove the plastic bag from bucket (even if the castor wheels are not needed).

# QUICK START UP

## BEFORE STARTING TO USE THE DEHUMIDIFIER

### Note:

- Please first check the float is properly placed
- Water tank must be correctly installed for the dehumidifier to operate
- Do not remove the water tank while dehumidifier is in operation.

1. Hold the grip on both sides of the water tank and gently remove.

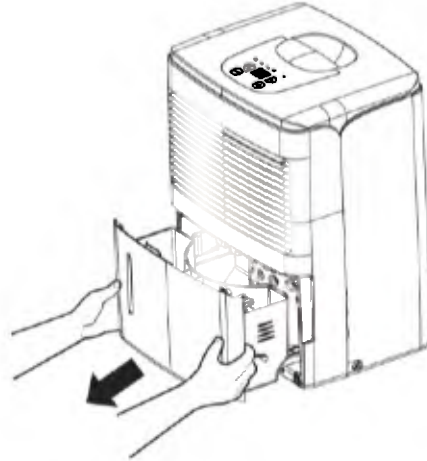

2. Check the float to ensure it is correctly aligned:

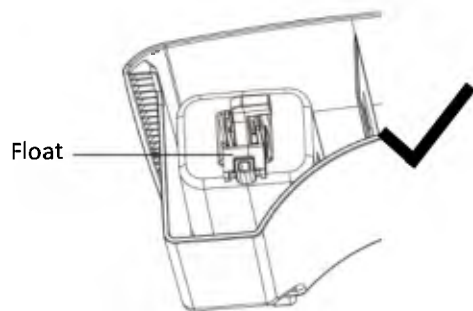

Correct Position

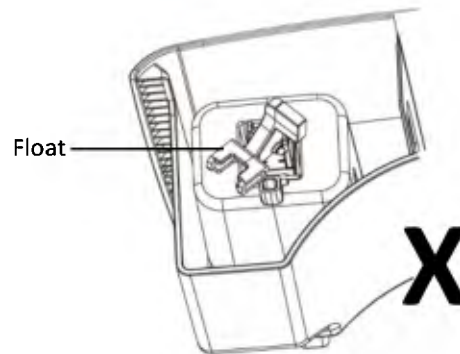

Wrong Position

3. Insert the water tank back to position:

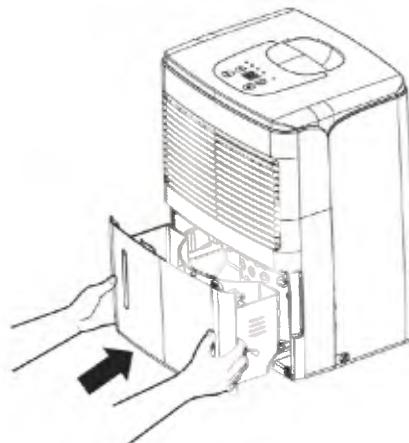



# SET UP & USE

## STEP 1 - WHERE TO POSITION YOUR DEHUMIDIFIER?

After unpacking your dehumidifier, place it upright to allow the compressor to stabilise for at least 4 hours before use.

Ensure the dehumidifier is a safe distance away from a wall or furniture, away from direct sunlight.

**TIP:** Position the dehumidifier in the dampest room or somewhere central like a landing or a hallway. As long as the internal doors are open the excess moisture from all of the rooms in the house will migrate naturally towards the dehumidifier and be processed.

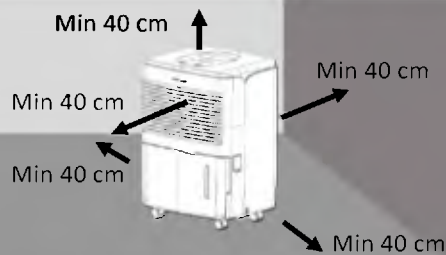

## STEP 3 - ON/OFF

### TO OPERATE UNIT

- Place the unit in an upright position on an even level surface.
- Plug the unit into the mains socket.
- The dehumidifier performs best at a minimum ambient temperature of 15°C . Where ambient temperature is below 15°C it may go into defrost mode periodically to preserve the life of the compressor.
- Press the ON/OFF button to operate the dehumidifier.
- Now select Mode. (See step 4)

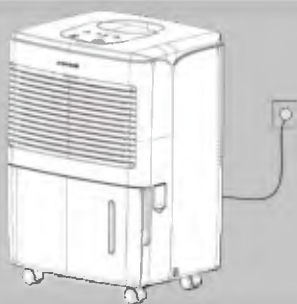

### USEFUL INFORMATION

**Memory Function** - If power is lost, all of the control settings are remembered. So when power is restored, the unit will start back up in the settings it was in when power was lost.

## STEP 2 - CAUTION - AVOID USING IN



- Areas where temperature falls below 5°C or above 32°C.
- Small confined area i.e. broom cupboard, boiler room, unventilated rooms etc.
- Close proximity to a heat source such as heater, tumble dryer, cooker.
- Do not attempt to roll the dehumidifier on carpet or over objects. Otherwise, water may spill out from the water tank or damage the unit.
- Dusty or building sites or an industrial environment where particles can clog up the filter or internal components. This will cause the unit to malfunction, voiding your guarantee.

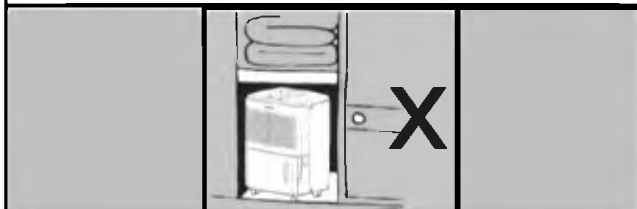

## STEP 4 - DRY MODE



Smart

### Select to keep the room at a comfortable level

- Select the smart mode to keep the room at a comfortable level between 45% - 55%RH. On this mode the unit will stop when the humidity reached its level and the unit will switch back on again when humidity level go up higher than this level.



Continuous Laundry Mode

### Select to run in Continuous Laundry mode

- The dehumidifier will operate continuously at its maximum dehumidification settings until setting is changed or the water tank is full.

**Note:** If connected to a hose pipe for continuous drainage the dehumidifier will continue operating on this settings with regular intervals of rests.

## STEP 5 - TANK FULL INDICATOR

- Indicator lights up when water tank is full or incorrectly inserted. The dehumidifier will automatically switch off.
- Remove water tank, empty and put it back correctly.

### Note:

If the tank is full or removed for more than a 3 minute period:

- an alarm will sound for about 10 seconds to alert the water tank needs emptying or placing back into position.
- The controls are disabled.

# EMPTY WATER TANK

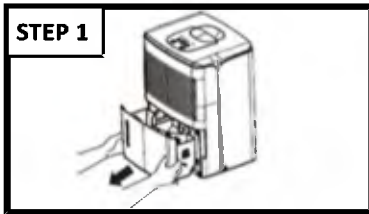

Pull water tank out

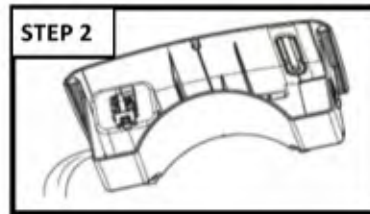

Pour the water away

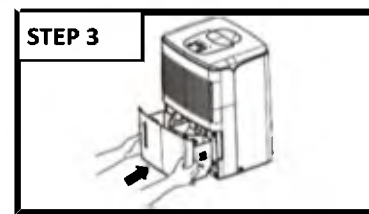

Insert the water tank

1. The Water Full Indicator lights up when the water tank is full and the unit stops operating.
2. Do not move the dehumidifier or remove the water tank when the dehumidifier is running, as water may leak; causing damages to the dehumidifier or an electric shock.
3. Before removing the water tank leave the dehumidifier to stand for approximately 10 minutes to ensure all water has dripped into the water tank.
4. Hold the grip on both sides of the water tank and pull it out following the arrow direction. (Attention: Gently pull out the tank to avoid water spill out onto the floor.) (See Step 1 picture)
5. To empty the tank, hold the grip with one hand and hold the base of the tank with other hand, pour the water away as step 2 picture. Then, clean the water tank, if needed.
6. Put the water tank back into the unit (See step 3 picture). Do not leave the unit without the water tank for not more than 5 minutes to avoid water leaking onto the floor.

## NOTE :

- Clean the water tank with clean water if needed. Do not use detergent, solvent, abrasive or hot water to avoid damaging the water tank or float.
- Do not remove or damage the float in the water tank or the dehumidifier will not operate properly.
- The water full light indicator illuminates if the water tank is not correctly in position.
- Do not tilt the dehumidifier when removing the water tank.
- If the water tank is removed whilst the dehumidifier is running the fan will continue to run for 3 minutes and it will stop.
- Do not tilt the dehumidifier when removing the water tank.
- If the water tank is removed whilst the dehumidifier is running the fan will continue to run for 3 minutes.

# CONTINUOUS DRAINAGE

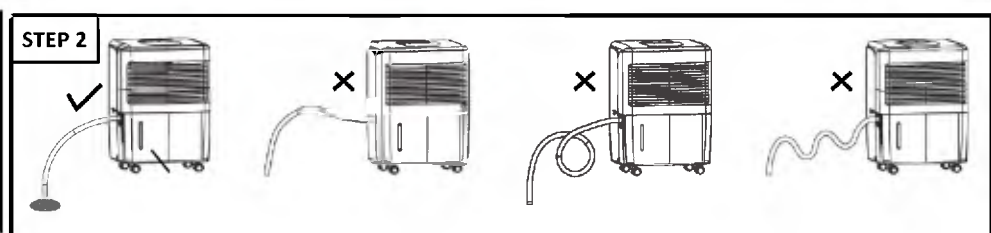
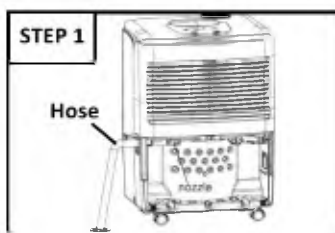

You may use a hose with an inner diameter of 14mm for continuous drainage (supplied):

1. Remove tank from the dehumidifier as instructed (Picture on Step 1). Lift up nozzle flap on the side of the dehumidifier, thread the drain hose into the nozzle and ensure it's securely inserted.

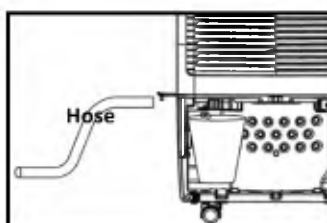

2. Replace the water tank. Make sure the drain hose goes through the drain hole on the sidepanel and is placed downward. The hose must lead to an appropriate drain at a downward slope with no sharp bends or the drain hose should not be kinked, otherwise water can not be drained out (Picture on Step 2)

**NOTE:** When removing the drain hose, use a cup to collect any dripping water from the nozzle.

# MAINTENANCE

## STEP 1 - CLEANING YOUR FILTER

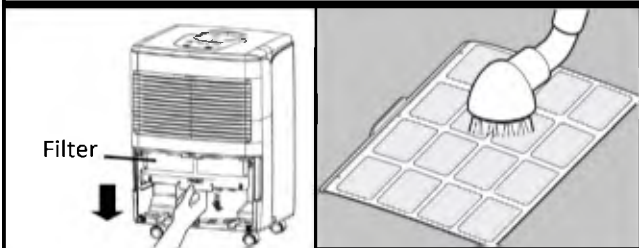

1. Turn OFF the dehumidifier and remove the filter from the unit. Hold the filter grip, pull it straight down and out.
2. Clean the filter use the vacuum cleaner or wash in warm, soap water, rinse it and let it air dry fully.
3. Replace the filter back into the right position.
4. If the filter is covered with dust, the airflow and the performance of the dehumidifier will be affected. Check the filter periodically to ensure all dust is removed.

**Tip:** Clean your filter once every 2 weeks to keep your air clean and prolong the life of your dehumidifier. The frequency will depend on conditions of operation.

## STEP 2 - REPLACING YOUR FILTER

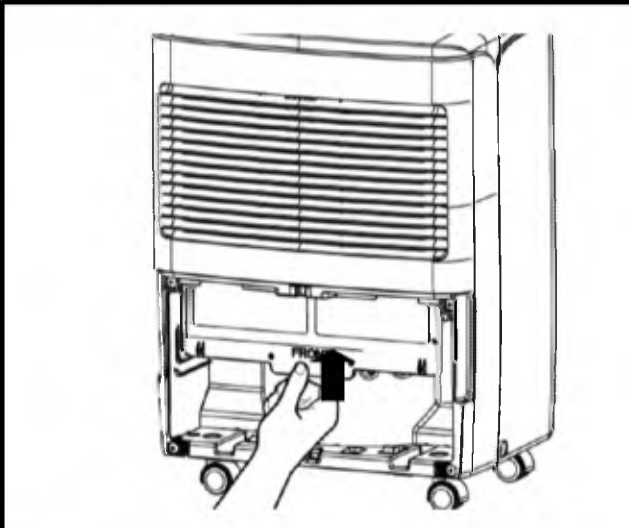

It is recommended that the filter is replaced every year for optimal performance and hygiene standards. The frequency depends on the duration and conditions of operation. To purchase a replacement filter please visit:

[www.ecoairdirect.com](http://www.ecoairdirect.com)

## STEP 3- CLEANING YOUR DEHUMIDIFIER

1. Turn the dehumidifier OFF, wait for the fan to stop and unplug the unit from the socket.

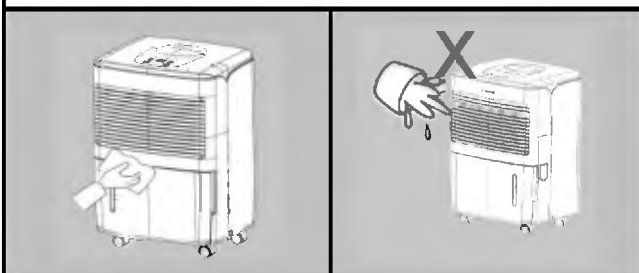

3. Clean the surface with a soft damp cloth.
3. Dry thoroughly with a dry towel after cleaning.
4. Empty the water tank. Allow water tank to dry or dry with a cloth.
5. Please take care when cleaning or drying around the float area.

### Caution:

- Do not wash the unit or immerse in water.
- Do not let water drip into the air inlet or outlet.

## STEP 4 - STORING YOUR DEHUMIDIFIER

1. Turn OFF the dehumidifier, wait for the fan to stop and unplug the dehumidifier from the power socket.
2. Leave the dehumidifier to drain for approximately one day. Clean and dry the water tank.
3. Clean the filter and the dehumidifier. Cover the dehumidifier to prevent it from gathering dust. Store upright in a cool dry place.
4. Do not expose to direct sunlight.



# IMPORTANT SAFETY INSTRUCTIONS

**PLEASE READ ALL INSTRUCTIONS CAREFULLY BEFORE OPERATING.**

**WARNING!** This dehumidifier is intended for domestic and light office use only. Any other use is not recommended by the manufacturer and may cause fire, electrical shocks or other injuries to person or property.

**When using electrical appliances, basic safety precautions should always be followed:**



1. Do not operate the dehumidifier where there is a damaged cord or plug or after it malfunctions or it has been dropped or damaged in any way. Arrange for the dehumidifier to be examined or repaired by an authorised technician.
2. Always keep the dehumidifier in an upright position to avoid any damage. Place the dehumidifier on an even level surface during operation.
3. Ensure the household voltage matches the rated specification for the dehumidifier before use.
4. Operate this dehumidifier in an ambient temperature between 5°C and 32°C.
5. Ensure that the air inlets and outlets are not blocked or covered. Do not insert fingers or any objects into the air inlet or outlet openings.
6. Do not place the unit too close to curtains or other objects, keep minimum distance of 40cm.
7. When using the "LAUNDRY" mode to dry wet clothes efficiently, keep the laundry at a safe distance from the dehumidifier to prevent water from dripping onto the dehumidifier.
8. Never place anything on top of the dehumidifier and do not cover while in use or before it cools down.
9. To protect against electrical shocks, do not immerse or spray the dehumidifier or any of its parts in water.
10. Never unplug the power cord without switching OFF the dehumidifier first.
11. Always unplug the dehumidifier when not in use or when moving location. To disconnect the dehumidifier from the power supply, grip the plug and pull from the power socket. Never pull by the cord.
12. Always empty the water tank before storing the unit away.
13. Close supervision is necessary when the dehumidifier is used in the presence of children and pets.
14. Do not run power cord under carpeting, or cover with rugs or runners. Arrange the cord away from areas where it may become a tripping hazard.
15. Never operate or store the dehumidifier in direct sunlight.
16. Repairs must be carried out by an authorised technician, failure to do so may cause damage to the dehumidifier or injury to persons or property and void the warranty. Always insist on original spare parts.
17. Avoid the using of an extension cable as they may overheat and cause a risk of fire.
18. Do not use the dehumidifier without the air filter. Clean or replace the air filter regularly.
19. Dispose of the water collected from the dehumidifier, this water is not drinkable.
20. Do not leave the dehumidifier unattended in continuous drainage over a long period of time.
21. At the end of its working life dispose the dehumidifier responsibly, in accordance with local by laws.
22. Do not remove the water tank when running, this may cause water to leak.
23. This dehumidifier is equipped with a safety tip-over technology switch. If the dehumidifier is tipped over it will automatically switch off.

This dehumidifier is not intended for use by persons (including children) with reduced physical, sensory or mental capabilities, unless they have been given supervision or instruction concerning use of the dehumidifier by a person responsible for their safety. Children should be supervised to ensure that they do not play with the dehumidifier.

**READ & SAVE THESE IMPORTANT SAFETY INSTRUCTIONS FOR FUTURE REFERENCE**

# TROUBLESHOOTING

## THE FOLLOWING POINTS BEFORE CONTACTING TECHNICAL SUPPORT.

PROBLEM	REASON	SOLUTION
 <b>No Power</b>	Dehumidifier is not plugged in or there is no power supply	Plug the dehumidifier into mains and switch plug ON. Check the main power supply
	Dehumidifier has reached its pre-set level or tank is full.	The dehumidifier automatically turns off when smart mode condition occurs or the tank is full. Empty the tank and replace properly or select continuous (laundry) mode .
	Water tank is not in the proper position.	The water tank must be in place and securely seated for the dehumidifier to operate.
	Power failure/Controls cannot be set	There is a protective time delay to protect the compressor. For this reason, the dehumidifier may not start normal dehumidifying for 3 minutes after it is turned back on.
 <b>Water Full Light On</b>	Water tank is full or installed incorrectly	Empty water tank or re-install correctly
	Water float out of position	Restore water float back into position
	Dehumidifier on uneven surface or water tank fitted incorrectly	Ensure the dehumidifier is on a flat, even surface, use a spirit level to check, remove tank and replace correctly
<b>Water Leaking</b>	Damaged water tank	Remove the water tank, fill with water and place on a hard even surface to test for leaking.
	The continuous drainage is clogged or loose Dehumidifier operating in colder environment Do not use in dusty environment and Clean the air filter regularly.	Check the continuous drainage hose and its connection Ensure room is within operating temperatures. Do not use in dusty environment or the filter not maintain correctly.
<b>Not Collecting Water</b>	Did not allow enough time to remove moisture	When first installed, allowed at least 24 hours to maintain the desired dehumidification
	Set Smart mode reached	Reset to continuous (laundry) mode
	Room is very cold or very dry for the current settings	Check room temperature and humidity levels eg. Humidity low or room cold Check room temperature and Increase the room temperature or set on continuous mode
	Filter dusty	Clean the air filter or replace it
	Room Temperature is too hot	Open the window or door to ventilate
	Room Temperature is too cold or humidity is low	Increase heat in the room Not much moisture in the room
<b>Noisy</b>	Water tank or filter fitted incorrectly Dehumidifier on uneven surface	Check and refit the water tank or filter Check dehumidifier is on an even level surface
	There is sound created when wind passing the dehumidifier.	This is normal
	Dehumidifier is placed on uneven floor	Place your dehumidifier on even floor
<b>Frost Appears on Coils</b>	Dehumidifier has been recently turned on, or room temperature is below 5°C	This is normal. Frost will usually disappear within 60 minutes. Do not operate the dehumidifier in temperatures below 5°C
<b>Dehumidifier Run Too Much</b>	Area to be dehumidified is too large	The capacity of your dehumidifier may not be adequate.
<b>No Response on Control</b>	Dehumidifier work out of temperature range	The dehumidifier is working out of the temperature range which higher than 32°C or below 5°C

**In the unlikely event of a problem with your product, please refer in the first instance to:**  
**ECOAIR TECHNICAL SUPPORT**  
[www.ecoair.org/support](http://www.ecoair.org/support)

# SPECIFICATIONS

MODEL	ESSENTIAL	
Temperature Range	5°C ~ 32°C	
Dehumidification Extraction Rate	30°C, 80%RH	10 Litres / day
	Max	12 litres / day
Water Tank Capacity	1.5 Litres	
Voltage	220 - 240V~50Hz	
Net Weight	11.5 Kg	
Gross Weight	12.5 Kg	
Net Dimension (W x H x D)	310mm x 400mm x 243mm	
Gross Dimension (W x H x D)	345mm x 425mm x 298mm	

# GUARANTEECARD

## TWO (2) YEAR LIMITED GUARANTEE

### SAVE THIS GUARANTEE INFORMATION

**EcoAir** guarantees this product free from defects in materials and workmanship for a period of Two (2) years from the date of purchase. Coverage is valid only with proof of purchase.

Exclusions: This guarantee does not cover:-

- Products used in the conditions other than the settings recommended and at the voltage indicated.
- Products used in a commercial setting or dusty environment.
- Service which do not involve malfunction or defects in materials or workmanship or those used other than in accordance with provided instructions.
- Appliance acquired second hand.
- Surcharges including, but not limited to, any after hour, weekend or holiday service calls and delivery charges.
- Damages caused by services performed by unauthorised service companies or use of parts other than genuine EcoAir parts or external causes; such as abuse, incorrect power supply, accidents, fires or acts of God.
- Replacement accessories such as filters.

This guarantee is in addition to, and does not affect, your Statutory Rights.

We recommend that you note the details of your purchase below and retain your original proof of purchase receipt with this user guide. Keep these documents safe in the event of a guarantee claim.

---

**Date of purchase:**

---

**Retailer Name:**

---

**Serial number:**

This limited guarantee only applies in the United Kingdom. Where the product has been taken from the country it was purchased to another country, the guarantee may be invalidated. However, we will always do our best to assist you in your new country of residence. EcoAir authorises no person to change or add to any obligations under this guarantee. Obligations for service and parts under this guarantee must be performed by EcoAir or an authorised service company. Product features or specification described may be subject to change without notice.



[www.ecoair.org](http://www.ecoair.org)











